

USER MANUAL



QuickVu

Ref. QVU150



ANALOG WAY®
Pioneer in Analog, Leader in Digital

—○ **THANK YOU**

By following these simple steps you will be able to obtain the most from your powerful **QuickVu** and its many features.

—○ 1. TRADEMARKS	6
—○ 2. INTRODUCTION	6
—○ 3. TERMS AND DEFINITIONS	7
—○ 4. HARDWARE SPECIFICATIONS	8
4.1 Safety instructions	8
4.1.1 English	
4.1.2 French	
4.1.3 Italian	
4.1.4 German	
4.1.5 Spanish	
4.2 Unpacking and inspection	13
4.3 Rack mount information	13
4.4 Cable and adaptor information	14
4.5 Hardware specifications	14
4.5.1 Signal descriptions	
4.5.2 Supported video formats	
4.5.3 Computer formats	
4.5.4 Input Computer formats	
4.5.5 Output Computer formats	
4.6 Input specifications	16
4.7 Output specifications	18
4.7.1 Standard output	
4.8 Communication specifications	19
4.8.1 Serial interface	
4.8.2 LAN interface	
4.9 Environmental specifications	20
4.10 HDCP management	21
4.10.1 Input HDCP detection	
4.10.2 Output HDCP detection	
4.10.3 Keys' checking	
4.10.4 Output management	
4.10.5 HDCP Classification	
4.10.6 Status	

—○ 5. CONNECTING THE QUICKVU	22
5.1 Description	22
5.1.1 Rear panel	
5.1.2 Front panel	
—○ 6. CONTROLLING THE QUICKVU	24
6.1 RCS ² requirement	24
6.2 Connecting with the RCS ²	24
6.3 RCS ² top menu	26
6.3.1 Setup	
6.3.2 Edit	
6.3.3 Live	
—○ 7. OPERATING THE QUICKVU FROM THE RCS ²	27
7.1 Operating mode	27
7.2 Setup	27
7.2.1 Mode	
7.2.2 Audio	
7.2.3 Screens	
7.2.4 Preview	
7.2.5 Misc	
7.2.6 Output management	
7.2.7 Input management	
7.2.8 Frame management	
7.2.9 Audio management	
7.2.10 Service management	
7.2.11 Control management	
7.3 Edit	39
7.3.1 Layer management	
7.3.2 Layer adjustments	
7.3.3 Effects	
7.3.4 Preset load and save management	
7.4 Live	44
—○ 8. OPERATING THROUGH THE FRONT PANEL	46
8.1 Front panel	46
8.1.1 Menu navigation	
8.1.2 Home menu	
8.1.3 Operating modes	
8.1.4 Resetting default values	
8.1.5 QuickVu color codes	

8.2 Settings in Mixer mode	47
8.2.1 Source Input selection	
8.2.2 Input selection settings	
8.2.3 Source Output selection	
8.2.4 Output selection settings	
8.2.5 Preview features	
8.2.6 Preview Id	
8.2.7 Working with layers	
8.2.8 Working with layers functions	
8.2.9 Opening transitions and closing live layers	
8.2.10 Layer adjustment menu	
8.2.11 Layers with transitions	
8.2.12 Capturing frames	
8.2.13 Working with frames	
8.2.14 Frame input setup menu	
8.2.15 Creating presets	
8.2.16 Working with presets	
8.2.17 Working with audio	
8.2.18 Special features	
8.3 Menu tree	57
9. MAINTENANCE AND SUPPORT	81
9.1 Dashboard (RCS ²)	81
10. APPLICATIONS NOTE AND TIPS	82
10.1 HDCP	82
11. WARRANTY	83
11.1 Warranty conditions	83
11.2 Repair and return instructions	83
11.3 Return conditions	83
12. CONTACT INFORMATION	84
13. APPENDICES	85
13.1 Crestron 2&3 series Midra™ Driver	85
13.2 AMX NetLinx® Integrated Controllers Midra™ Driver	85

—○ 1. TRADEMARKS

The terms HDMI, HDMI High-Definition Multimedia Interface and the HDMI logo are trademarks or registered trademarks of HDMI Licensing LLC in the United States and other countries.

—○ 2. INTRODUCTION

Thank you for choosing the Analog Way **QuickVu**. Before you start setting up your **QuickVu** for the first time, please read through all of the documentation to become familiar with its powerful features. The **QuickVu** can be used in several configurations, which results in a versatile video production tool for live event staging and fixed installation applications.

3. TERMS AND DEFINITIONS

BACKGROUND: a “Background” is a source, typically originating from a computer. **QuickVu** enables you to work with still (frame) background — visually in back of all other sources.

LAYER: a “layer” is an image display element (such as a PIP window, Key, logo or Background) that has a visual priority — either in front (or in back) of another layer. 1 frame non-resizable, up to 2 live layers resizable available on the **QuickVu**.

PIP: a “PIP” (Picture In Picture) is a picture, typically of reduced size, which is positioned over another background image or other PIPs. PIPs can be repositioned, reduced, enlarged and displayed. PIPs can overlap, depending on their visual priority. **QuickVu** offers various slides, wipes, and fades for dynamic PIP entrances and exits. A “flying” PIP is also possible using vertical, horizontal, or diagonal movement. A PIP is considered as a layer.

FRAME: a “frame” is a full screen image which is selected from one of the still frames you can capture. A frame can be captured in flash memory from any video or computer source plugged into the machine.

KEYING: “Key” is an electronic process whereby a video image is electronically superimposed over another source or background, by dynamically removing a portion of the first image. For example, removing all content of a certain color (such as green or blue) is called a Chroma Key, and removing content based on its brightness or luminance levels is called a (Luma Key). Keys are typically used for titles, logos and special effects. **QuickVu** allows you to key a live source (such as a camera shot with green or blue background, or a title with a black background) over any other source or sources.

SEAMLESS: Clean transition with no glitch or loss of sync while switching between two sources. For example, fading through black to another source is a seamless transition.

TRUE SEAMLESS: Clean seamless transitions with no glitch or freeze between two sources. For example, crossfading from source to source is a true seamless transition.

RCS²: Remote Control Software used to control, set up, and operate the device.

QUICK FRAME: The “Quick Frame” feature allows the instant display of a stored frame above all layers.

4. HARDWARE SPECIFICATIONS

4.1 Safety instructions

4.1.1 English

All of the safety and operating instructions should be read before the product is operated and should be maintained for further reference. Please follow all of the warnings on this product and its operating instructions.

- **WARNING:** To prevent the risk of electric shock and fire, do not expose this device to rain, humidity or intense heat sources (such as heaters and direct sunlight). Slots and openings in the device are provided for ventilation and to avoid overheating. Make sure the device is never placed near a textile surface that could block the openings. Also keep away from excessive dust, vibrations and shocks.
- **POWER:** Only use the power supply indicated on the device of the power source. Devices equipped with a grounding plug should only be used with a grounding type outlet. In no way should this grounding be modified, avoided or suppressed. Connection of equipment to main supply must be after branch circuit breaker of the building installation.
- **POWER CORD:** The device is equipped with a detachable power cord, to remove mains disconnect it at appliance coupler. A rear switch is also available, turn OFF to switch off the device.

Caution: The power cord constitutes the only mean to completely disconnect the equipment from the main power.

Apply the following guidelines:

- The equipment connected to the network must have a release system easily accessible and located outside the unit.
- Unplug the power cord; do not pull on the power cord but always on the plug itself.
- The outlet should always be near the device and easily accessible.
- Power supply cords should be routed so that they are not likely to be walked on or pinched by items placed upon or against them.

If the power supply cord is damaged, unplug the device. Using the device with a damaged power supply cord may expose your device to electric shocks or other hazards. Verify the condition of the power supply cords once in a while. Contact your dealer or service center for replacement if damaged.

- **CONNECTIONS:** All inputs and outputs (except for the power input) are Safety Extra Low Voltage (SELV) circuits as defined in UL/IEC 60950-1.
- **SERVICING:** Do not attempt to service this product yourself by opening or removing covers and screws since it may expose your device to electric shocks or other hazards. Refer all problems to qualified service personnel. You may lose warranty when you open the unit.
- **OPENINGS:** Never push objects of any kind into this product through the openings. If liquids have been spilled or objects have fallen into the device, unplug it immediately and have it checked by a qualified technician.

4.1.2 French

Afin de mieux comprendre le fonctionnement de cet appareil nous vous conseillons de bien lire toutes les consignes de sécurité et de fonctionnement avant utilisation. Conservez les instructions de sécurité et de fonctionnement afin de pouvoir les consulter ultérieurement. Respectez toutes les consignes marquées dans la documentation, sur le produit et sur ce document.

- **ATTENTION** : Afin de prévenir tout risque de choc électrique et d'incendie, ne pas exposer cet appareil à la pluie, à l'humidité ou à des sources de chaleur intense.
- **INSTALLATION** : Veillez à assurer une circulation d'air suffisante pour éviter toute surchauffe à l'intérieur de l'appareil. Ne placez pas l'appareil sur ou à proximité d'une surface textile susceptible d'obstruer les orifices de ventilation. N'installez pas l'appareil à proximité de sources de chaleur comme un radiateur ou une poche d'air chaud, ni dans un endroit exposé au rayonnement solaire direct, à des poussières excessives, à des vibrations ou à des chocs mécaniques. Ceci pourrait provoquer un mauvais fonctionnement et un accident.
- **ALIMENTATION** : Ne faire fonctionner l'appareil qu'avec la source d'alimentation indiquée sur l'appareil. Les appareils doivent être obligatoirement connectés sur une source équipée d'une mise à la terre efficace. En aucun cas cette liaison de terre ne devra être modifiée, contournée ou supprimée. Raccordement des équipements à l'alimentation principale doit être postérieur au disjoncteur de branchement de l'installation électrique du bâtiment.
- **CORDON D'ALIMENTATION** : Les appareils sont équipés d'un cordon d'alimentation détachable, la mise hors tension se fait en débranchant ce cordon de l'appareil. L'appareil possède un interrupteur en face arrière, appuyez dessus pour éteindre l'appareil.

Attention : le cordon d'alimentation constitue le seul moyen de débrancher l'appareil totalement de l'alimentation secteur. Pour être certain que l'appareil n'est plus alimenté, ce cordon doit être débranché de la prise murale.

Appliquer les consignes suivantes :

- Le matériel relié à demeure au réseau, doit avoir un dispositif de sectionnement facilement accessible qui doit être incorporé à l'extérieur de l'appareil.
- Débrancher le cordon d'alimentation de la prise murale si vous prévoyez de ne pas utiliser l'appareil pendant quelques jours ou plus.
- Pour débrancher le cordon, tirez-le par la fiche. Ne tirez jamais sur le cordon proprement dit.
- La prise d'alimentation doit se trouver à proximité de l'appareil et être aisément accessible.
- Ne laissez pas tomber le cordon d'alimentation et ne posez pas d'objets lourds dessus.

Si le cordon d'alimentation est endommagé, débranchez-le immédiatement de la prise murale. Il est dangereux de faire fonctionner un appareil avec un cordon endommagé ; un câble abîmé peut provoquer un risque d'incendie ou un choc électrique. Vérifiez le câble d'alimentation de temps en temps. Contactez votre revendeur ou le service après-vente pour un remplacement.

- **CONNEXIONS** : Toutes les entrées et sorties (exceptée l'entrée d'alimentation) sont des circuits de très basse tension de sécurité (TBTS) tels que définis dans UL / IEC 60950-1.
- **RÉPARATION ET MAINTENANCE** : L'utilisateur ne doit en aucun cas essayer de procéder aux opérations de dépannage, car l'ouverture des appareils par retrait des capots ou de toutes autres pièces constituant les boîtiers ainsi que le dévissage des vis apparentes à l'extérieur, risquent d'exposer l'utilisateur à des chocs électriques ou autres dangers. Contactez le service après-vente, votre revendeur ou adressez-vous à un personnel qualifié uniquement. L'ouverture de l'appareil provoque la perte de la garantie.
- **OUVERTURES ET ORIFICES** : Les appareils peuvent comporter des ouvertures (aération, fentes, etc...), veuillez ne jamais y introduire d'objets et ne jamais obstruer ses ouvertures. Si un liquide ou un objet pénètre à l'intérieur de l'appareil, débranchez immédiatement l'appareil et faites-le contrôler par un personnel qualifié avant de le remettre en service.

4.1.3 Italian

Allo scopo di capire meglio il funzionamento di questa apparecchiatura vi consigliamo di leggere bene tutti i consigli di sicurezza e di funzionamento prima dell'utilizzo. Conservare le istruzioni di sicurezza e di funzionamento al fine di poterle consultare ulteriormente. Seguire tutti i consigli indicati su questo manuale e sull'apparecchiatura.

- **ATTENZIONE:** Al fine di prevenire qualsiasi rischio di shock elettrico e d'incendio, non esporre l'apparecchiatura a pioggia, umidità e a sorgenti di eccessivo calore.
- **INSTALLAZIONE:** Assicuratevi che vi sia una sufficiente circolazione d'aria per evitare qualsiasi surriscaldamento all'interno dell'apparecchiatura. Non collocare l'apparecchiatura in prossimità o su superfici tessili suscettibili di ostruire il funzionamento della ventilazione. Non installate l'apparecchiatura in prossimità di sorgenti di calore come un radiatore o una fuoruscita d'aria calda, né in un posto esposto direttamente ai raggi del sole, a polvere eccessiva, a vibrazioni o a shock meccanici. Ciò potrebbe provocare un erroneo funzionamento e un incidente.
- **ALIMENTAZIONE:** Far funzionare l'apparecchiatura solo con la sorgente d'alimentazione indicata sull'apparecchiatura. Le apparecchiature queste devono essere obbligatoriamente collegate su una sorgente fornita di una efficiente messa a terra. In nessun caso questo collegamento potrà essere modificato, sostituito o eliminato. Connessione delle apparecchiature alla rete elettrica deve essere successiva interruttore di circuito dell'impianto dell'edificio
- **CAVO DI ALIMENTAZIONE:** Il dispositivo è dotato di un cavo di alimentazione removibile, per rimuovere alimentazione scollegarlo dalla Presa. L'interruttore di accensione è disponibile sul pannello posteriore, posizionarlo su OFF per spegnere il dispositivo.

Attenzione: il cavo di alimentazione è il solo modo di disconnettere l'apparecchio dell'alimentazione. Per assicurarsi che totalmente l'apparecchio non è più collegato, il cavo deve essere disconnesso della presa murale.

Seguire le istruzioni seguenti:

- Il materiale collegato a residenza alla rete, deve avere un dispositivo di sezionamento facile da raggiungere e che deve essere inserito all'esterno del apparecchio.
- Disconnettere l'apparecchiatura dalla presa murale se si prevede di non utilizzarla per qualche giorno.
- Per disconnettere il cavo tirare facendo forza sul connettore.
- La presa d'alimentazione deve trovarsi in prossimità dell'apparecchiatura ed essere facilmente accessibile.
- Non far cadere il cavo di alimentazione né appoggiarci sopra degli oggetti pesanti. Se il cavo di alimentazione è danneggiato, spegnere immediatamente l'apparecchiatura.

È pericoloso far funzionare questa apparecchiatura con un cavo di alimentazione danneggiato, un cavo graffiato può provocare un rischio di incendio o uno shock elettrico. Verificare il cavo di alimentazione spesso. Contattare il vostro rivenditore o il servizio assistenza per una sostituzione.

- **CONNESSIONE:** Tutti gli ingressi e le uscite (tranne che per la potenza in ingresso) sono bassissima tensione di sicurezza (SELV) circuiti definiti UL / IEC 60950-1.
- **RIPARAZIONI E ASSISTENZA:** L'utilizzatore non deve in nessun caso cercare di riparare l'apparecchiatura, poiché con l'apertura del coperchio metallico o di qualsiasi altro pezzo costituente la scatola metallica, nonché svitare le viti che appaiono esteriormente, poiché ciò può provocare all'utilizzatore un rischio di shock elettrico o altri rischi. Qualora si apra l'unità, la garanzia non sarà più valida.
- **APERTURE DI VENTILAZIONE:** Le apparecchiature possono comportare delle aperture di ventilazione, si prega di non introdurre mai oggetti o ostruire le sue fessure. Se un liquido o un oggetto penetra all'interno dell'apparecchiatura, disconnetterla e farla controllare da personale qualificato prima di rimetterla in servizio.

4.1.4 German

Um den Betrieb dieses Geräts zu verstehen, raten wir Ihnen vor der Inbetriebnahme alle Sicherheits- und Betriebsanweisungen genau zu lesen. Diese Sicherheits- und Betriebsanweisungen für einen späteren Gebrauch sicher aufbewahren. Alle in den Unterlagen, an dem Gerät und hier angegebenen Sicherheitsanweisungen einhalten.

- **ACHTUNG:** um jegliches Risiko eines Stromschlags oder Feuers zu vermeiden, das Gerät nicht Regen, Feuchtigkeit oder intensiven Wärmequellen aussetzen.
- **EINBAU:** Eine ausreichende Luftzufuhr sicherstellen, um jegliche Überhitzung im Gerät zu vermeiden. Das Gerät nicht auf und in Nähe von Textiloberflächen, die Belüftungsöffnungen verschließen können, aufstellen. Das Gerät nicht in Nähe von Wärmequellen, wie z.B. Heizkörper oder Warmluftkappe, aufstellen und es nicht dem direkten Sonnenlicht, übermäßigem Staub, Vibrationen oder mechanischen Stößen aussetzen. Dies kann zu Betriebsstörungen und Unfällen führen.
- **STROMVERSORGUNG:** Das Gerät nur mit der auf dem Gerät bezeichnete Stromquelle betreiben. Gerät mit geerdeter Hauptstromversorgung muss an eine Stromquelle mit effizienter Erdung angeschlossen werden. Diese Erdung darf auf keinen Fall geändert, umgangen oder entfernt werden. Anschluss von Geräten ans Stromnetz muss nach Abzweigschalter des Gebäudes Installation
- **NETZKABEL:** Das Gerät ist mit einem lösbaren Netzkabel ausgestattet ; um es völlig vom Netz zu trennen, ziehen Sie bitte das Netzkabel aus der Kaltgerätebuchse. Des Weiteren befindet sich auf der Rückseite ein Schalter, mit dem das Gerät ausgeschaltet werden kann.

Achtung: Das Netzkabel stellt die einzige Möglichkeit dar, das Gerät vollständig vom Netzanschluss zu trennen. Um sicherzustellen, dass das Gerät nicht mehr versorgt wird, muss dieses Kabel aus der Netzsteckdose ausgesteckt werden.

Bitte beachten Sie die folgenden Hinweise:

- Wenn Geräte dauerhaft am Netz bleiben, müssen sie über eine leicht zugängliche Trennvorrichtung verfügen, die außen am Gerät angebracht sein muss.
- Das Kabel mittels dem Stecker herausziehen. Niemals am Stromkabel selbst ziehen.
- Die Steckdose muß sich in der Nähe des Geräts befinden und leicht zugänglich sein.
- Das Stromkabel nicht fallen lassen und keine schweren Gegenstände auf es stellen.

Wenn das Stromkabel beschädigt ist, das Gerät sofort abschalten. Es ist gefährlich das Gerät mit einem beschädigten Stromkabel zu betreiben; ein abgenutztes Kabel kann zu einem Feuer oder Stromschlag führen. Das Stromkabel regelmäßig untersuchen. Für den Ersatz, wenden Sie sich an Ihren Verkäufer oder Kundendienststelle.

- **ANSCHLÜSSE:** Alle Eingänge und Ausgänge (mit Ausnahme der Stromversorgung) sind Safety Extra Low Voltage (SELV) Schaltungen wie in UL / IEC 60950-1 definiert.
- **REPARATUR UND WARTUNG:** Der Benutzer darf keinesfalls versuchen das Gerät selbst zu reparieren, die Öffnung des Geräts durch Abnahme der Abdeckhaube oder jeglichen anderen Teils des Gehäuses sowie die Entfernung von außen sichtbaren Schrauben zu Stromschlägen oder anderen Gefahren für den Benutzer führen kann. Wenden Sie sich an Ihren Verkäufer, Ihre Kundendienststelle oder an qualifizierte Fachkräfte. Das Öffnen des Gehäuses führt zum Verlust der Garantie.
- **ÖFFNUNGEN UND MUNDUNGEN:** Die Geräte können über Öffnungen verfügen (Belüftung, Schlitze, usw.). Niemals Gegenstände in die Öffnungen einführen oder die Öffnungen verschließen. Wenn eine Flüssigkeit oder ein Gegenstand in das Gerät gelangt, den Stecker herausziehen und es vor einer neuen Inbetriebnahme von qualifiziertem Fachpersonal überprüfen lassen.

4.1.5 Spanish

Para comprender mejor el funcionamiento de este aparato, le recomendamos que le acuidadosamente todas las consignas de seguridad y de funcionamiento del aparato antes de usarlo. Conserve las instrucciones de seguridad y de funcionamiento para que pueda consultarlas posteriormente. Respete todas las consignas indicadas en la documentación, relacionadas con el producto y este documento.

- **CUIDADO:** Para prevenir cualquier riesgo de choque eléctrico y de incendio, no exponga este aparato a la lluvia, a la humedad ni a fuentes de calor intensas.
- **INSTALACIÓN:** Cerciórese de que haya una circulación de aire suficiente para evitar cualquier sobrecalentamiento al interior del aparato. No coloque el aparato cerca ni sobre una superficie textil que pudiera obstruir los orificios de ventilación. No instale el aparato cerca de fuentes de calor como radiador o boca de aire caliente, ni en un lugar expuesto a los rayos solares directos o al polvo excesivo, a las vibraciones o a los choques mecánicos. Esto podría provocar su mal funcionamiento o un accidente.
- **ALIMENTACIÓN:** Ponga a funcionar el aparato únicamente con la fuente de alimentación que se indica en el aparato. Los aparatos deben estar conectados obligatoriamente a una fuente equipada con una puesta a tierra eficaz. Por ningún motivo este enlace de tierra deberá ser modificado, cambiado o suprimido. Conexión del equipo a la red eléctrica debe ser posterior del interruptor de circuitos derivados de la instalación del edificio
- **CABLE DE CORRIENTE:** El equipo se suministra con un cable de corriente si desconectamos el cable dejamos al equipo sin alimentación. Un interruptor situado en la trasera de la unidad, permite apagar el equipo.

Atención: El cable de alimentación constituye el único medio de desconectar el aparato totalmente de la red eléctrica. Para estar seguro de que el aparato no está más alimentado, este cable debe de ser desconectado de la toma de corriente.

Aplicar las siguientes consignas:

- El material conectado a residencia a la red informática, debe de tener un dispositivo de seccionamiento fácilmente accesible que debe de ser incorporado al exterior del aparato.
- Desconectar el aparato del enchufe mural si no piensa utilizarlo durante varios días.
- Para desconectar el cable, tire de la clavija. No tire nunca del cable propiamente dicho.
- El enchufe de alimentación debe estar cerca del aparato y ser de fácil acceso.
- No deje caer el cable de alimentación ni coloque objetos pesados encima de él.

Si el cable de alimentación sufriera algún daño, ponga el aparato inmediatamente fuera de tensión. Es peligroso hacer funcionar este aparato con un cable averiado, ya que un cable dañado puede provocar un incendio o un choque eléctrico. Verifique el estado del cable de alimentación de vez en cuando. Póngase en contacto con su distribuidor o con el servicio de posventa si necesita cambiarlo.

- **CONEXIONES:** Todas las entradas y salidas (a excepción de la entrada de alimentación) son de tensión extra baja de seguridad (SELV) circuitos definidos en UL / IEC 60950-1.
- **REPARACIÓN Y MANTENIMIENTO:** Por ningún motivo, el usuario deberá tratar de efectuar operaciones de reparación, ya que si abre los aparatos retirando el capó o cualquier otra pieza que forma parte de las cajas o si destornilla los tornillos aparentes exteriores, existe el riesgo de producirse una explosión, choques eléctricos o cualquier otro incidente. Contacte el servicio de posventa, a su distribuidor o diríjase con personal cualificado únicamente. La unidad pierde la garantía si esta ha sido abierta.
- **ABERTURAS Y ORIFICIOS:** Los aparatos pueden contener aberturas (aireación, ranuras, etc.). No introduzca allí ningún objeto ni obstruya nunca estas aberturas. Si un líquido o un objeto penetra al interior del aparato, desconéctelo y hágalo revisar por personal cualificado antes de ponerlo nuevamente en servicio.

4.2 Unpacking and inspection

- 1 x **QuickVu (QVU150)**
- 1 x Power supply cord
- 1 x Ethernet cross cable (for device update)
- 1 x Remote Control Software (RCS²)*
- 1 x Set of 6 audio 5-pin screw terminals
- 1 x Front rack ears (the parts are stowed in the packaging foam)
- 1 x User manual (PDF)*
- 1 x Quick start guide*

* User manual, quick start guide and the RCS² are available on www.analogway.com

Before racking and plugging any inputs and outputs, it is advised to power on the unit. Should you encounter any issue, you must contact immediately your local distributor or dealer, or closest **Analog Way** technical support offices (see chapter: **12. Contact information**).

4.3 Rack mount information

Tabletop mounting: The **QuickVu** can be used directly on a table; the unit is equipped with 4 handy anti-slip rubber feet.

Rack mounting: The **QuickVu** is compatible with a 19" enclosure. Please follow the instructions below to install the device in a 19" rack.

Please put the ears on the unit thanks to the 4 provided screws.

Place the device in your rack. Attach the device to the rack by screwing 2 front ears on it (screws not included). Rear fixing is also recommended, in particular for permanent installations.

Connect all of the cables of the device and attach them to the rack with the help of tie wraps.

IMPORTANT:

- The openings in the side of the device are for cooling. Do not cover these openings to avoid blocking air circulation.
- Be sure that no weight in excess of 2 kg (4.4 Lbs.) is added onto the **QuickVu**.
- The maximum ambient operating temperature should not exceed 40°C (104°F).
- The rack and all mounted equipment in it must be reliably grounded according to national and/or local electrical standards.



Dismantling front handles of the device could invalidate warranty on after-sales services of your **QuickVu**. It is strongly advised to avoid using front handles as rests for your **QuickVu**, they are designed for manipulation purposes only.

If required, front handles of the device can be dismantled, but with caution. The original screws removed must not be reintroduced to their location without handles in place. Substantial damages can occur, including risk of electric shock from the main voltage. Only M4x12mm screws can be used. They are supplied with the unit.

4.4 Cable and adaptor information

A large choice of cables and adaptors are compatible with the **QuickVu**. Please refer to the hardware specifications chapter to find the most suitable cables for your operations.

4.5 Hardware specifications

4.5.1 Signal descriptions

For each type of signal, here are the levels and the impedance accepted by the **QuickVu**.

Analog SDTV

Type	Levels	Impedance
Composite	0,7 Vpp + 0,3 Vpp	75 Ω
S. Video	Y = 0,7 Vpp + 0,3 Vpp C = 0,7 Vpp	75 Ω
YUV	Y = 0,7 Vpp + 0,3 Vpp U = 0,7 Vpp V = 0,7 Vpp	75 Ω
RGsB	R = 0,7 Vpp G = 0,7 Vpp + 0,3 Vpp B = 0,7 Vpp	75 Ω
RGBS	R, G, B = 0,7 Vpp	R, G, B = 75 Ω
	S = 0,3 Vpp 75 Ω or S = TTL	

Analog EDTV

Type	Levels	Impedance
YUV	Y = 0,7 Vpp + 0,3 Vpp U = 0,7 Vpp V = 0,7 Vpp	75 Ω
RGsB	R = 0,7 Vpp G = 0,7 Vpp + 0,3 Vpp B = 0,7 Vpp	75 Ω
RGBS	R, G, B = 0,7 Vpp	R, G, B = 75 Ω
	S = 0,3 Vpp 75 Ω or S = TTL	

Analog HDTV

These formats are compatible with bi-level and tri-level sync on 1 or 3 wires.

Type	Levels	Impedance
YUV	Y = 0,7 Vpp ±0,3 Vpp U = 0,7 Vpp ±0,3 Vpp V = 0,7 Vpp ±0,3 Vpp	75 Ω
RGsB	R = 0,7 Vpp ±0,3 Vpp G = 0,7 Vpp ±0,3 Vpp B = 0,7 Vpp ±0,3 Vpp	75 Ω

Digital SDTV

Type	Characteristics
SD-SDI	YUV - 10 bits – 4.2.2 - 270 Mb/s No payload ID management Only A-level type
DVI	RGB ou YUV – 8 bits – 4.4.4 – 16/235 - TMDS
HDMI®	RGB or YUV – 8 bits – 4.4.4 or 4.2.2 – 16/235 – TMDS

Digital EDTV

Type	Characteristics
DVI	RGB or YUV – 8 bits – 4.4.4 – 16/235 - TMDS
HDMI®	RGB or YUV – 8 bits – 4.4.4 or 4.2.2 – 16/235 – TMDS

Digital HDTV

Type	Characteristics
HD-SDI	YUV - 10 bits – 4.2.2 – 1,485Gb/s and 1,485/1.001Gb/s Only A-level type Input and output payload ID management for HDTV format only
3G-SDI	YUV - 10 bits – 4.2.2 – 2,97Gb/s and 2,97/1.001Gb/s Only A-level type Input and output payload ID management for HDTV format only
DVI	RGB or YUV – 8 bits – 4.4.4 – 16/235 - TMDS
HDMI®	RGB or YUV – 8 bits – 4.4.4 or 4.2.2 – 16/235 – TMDS

Analog computer

Type	Levels	Impedance
RGsB	R = 0,7 Vpp G = 0,7 Vpp + 0,3 Vpp B = 0,7 Vpp	75 Ω
RGSB	R, G, B = 0,7 Vpp	R, G, B = 75 Ω
	S = 0,3 Vpp 75Ω or S = TTL	
RGBHV	R, G, B = 0,7 Vpp	R, G, B = 75 Ω
	H = TTL and V = TTL	

Digital computer

Type	Characteristics
DVI	RGB – 8 bits – 4.4.4 – 0/255 - TMDS
HDMI®	RGB or YUV – 8 bits – 4.4.4 or 4.2.2 – 0/255 – TMDS

4.5.2 Supported video formats

The **QuickVu** can support all the following video formats:

SDTV formats

Standard	Size	Vertical frequency	Horizontal frequency
NTSC	525/480i	59.94Hz/60Hz	15,735 KHz
PAL	625/576i	50Hz	15.625 KHz
SECAM	625/576i	50Hz	15.625 KHz

EDTV formats

Standard	Size	Vertical frequency	Horizontal frequency
480p	525/480p	59.94Hz/60Hz	31.47 KHz
576p	625/576p	50Hz	31.25 KHz

HDTV formats

Standard	Size	Vertical frequency
720p	1280 x 720	23.97Hz/24Hz/25Hz/29,97Hz/30Hz/50Hz/59.94Hz/60Hz
1035i	1920 x 1035	59.94Hz/60Hz
1080i	1920 x 1080	50Hz/59.94Hz/60Hz
1080sF	1920 x 1080	50Hz/59.94Hz/60Hz
1080p	1920 x 1080	23.97Hz/24Hz/25Hz/29,97Hz/30Hz/50Hz/59.94Hz/60Hz

Cinema formats

Format	Size	Vertical frequency
DCDM	2048 x 1080	24Hz

4.5.3 Computer formats

Important: The maximum pixel clock frequency is 165 MHz. Supported formats include 1920x1200 @ 60hz RB, 1600x1200 @60hz RB, 2048x1152 @60hz RB.

4.5.4 Input Computer formats

The **QuickVu** inputs support GTF (version 1.1), CVT (version 1.1) and DMT (version 1.0 rev 12) standards. All others non-standard formats are supported via the custom format capability of the framework.

4.5.5 Output Computer formats

The **QuickVu** outputs support GTF (version 1.1), CVT (version 1.1) and DMT (version 1.0 rev 12) standards. Other non-standard formats are supported via the custom format capability of the framework.

The **QuickVu** offers a list of pre-defined output formats.

Format	Size	Aspect ratio	Frequency	
			50 Hz	60 Hz
VGA	640x480	4/3	Yes	Yes
WVGA	848x480	16/9	Yes	Yes
SVGA	800x600	4/3	Yes	Yes
720p	1280x720	16/9	Yes	Yes
XGA	1024x768	4/3	Yes	Yes
WXGA	1280x768	5/3	Yes	Yes
SWXGA	1360x768	16/9	Yes	Yes
1366x768	1366x768	16/9	Yes	Yes
WXGA2	1280x800	16/9	Yes	Yes
SWXGAP	1366x800	5/3	Yes	Yes
	1152x864	4/3	Yes	Yes
900p	1440x900	16/10	Yes	Yes
	1440x900	3/2	Yes	Yes
	1600x900	16/9	Yes	Yes
	1280x960	4/3	Yes	Yes
SXGA	1280x1024	5/4	Yes	Yes
	1360x1024	4/3	Yes	Yes
SXGAP	1400x1050	5/3	Yes	Yes

Format	Size	Aspect ratio	Frequency	
			50 Hz	60 Hz
WSXGAP	1680x1050	16/9	Yes	Yes
1080p	1920x1080	16/9	Yes	Yes
2K	2048x1080	17/9	Yes	Yes
UXGA	1600x1200	4/3	Yes	Yes
WUXGA	1920x1200	16/9	Yes	Yes
	2048x1152	16/9	Yes	Yes

4.6 Input specifications

The **QuickVu** offers 8 seamless inputs. Some inputs contain several plugs.

A plug corresponds to a socket or a connector on the rear panel.

The following types of plugs are available on the rear panel:

- HDMI
- Single DVI-D (HDMI compatible),
- 3G/HD/SD-SDI (BNC),
- Universal Analog (HD-15)

The **QuickVu** uses an HDMI plug with a standard mounting screw above the connector. Please see the diagram below. This hole is occupied by a Torx10 screw when you receive the unit. If desired, this screw can be removed and replaced by a compatible aftermarket HDMI plug locking mechanism to ensure a secure HDMI connection. This threaded hole should not be left empty.

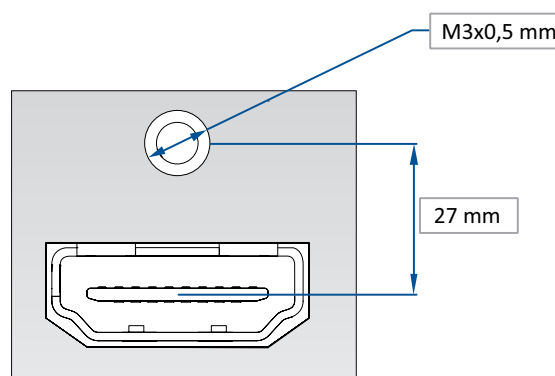

This hole is used by a TX10 screw when you receive the unit, if you wish to use an HDMI cable with a security fixing screw you can take this screw off and use your own in order to insure good fixing of your HDMI plug.

Please take a look at the accepted formats regarding the input plug type:

Plug Type	Formats	Signals
Universal Analog Input	SDTV - EDTV - HDTV - Computer	Analog SDTV - Analog EDTV - Analog HDTV - Analog Computer
DVI-D Input	SDTV - EDTV - HDTV - Computer	Digital SDTV - Digital EDTV - Digital HDTV - Digital Computer
HDMI Input	SDTV - EDTV - HDTV - Computer	Digital SDTV - Digital EDTV - Digital HDTV - Digital Computer
3G/HD/SD-SDI Input	SDTV - HDTV	Digital SDTV - Digital HDTV

WARNING: Only the video and audio signal is processed for the HDMI®, and 3G/HD/SD-SDI inputs; other embedded auxiliary features are not supported or passed through. The embedded audio is processed. All other HDMI® features such as: HDMI Ethernet Channel, Audio Return Channel, 3D, 4K, Content Type, Deep Color and x.v.Color are **NOT** supported.

Each input can display only one active plug at a time. It is instantly available on the device and can be displayed simultaneously on many layers or outputs, with different sizes and positions.

Standard	Size	HD-15	3G-SDI	HDMI	Single-Link DVI-D
NTSC	525/480i	Yes	Yes	Yes	No
PAL	625/576i	Yes	Yes	Yes	No
SECAM	625/576i	Yes	Yes	Yes	No
EDTV 480p	525/480p	Yes	No	Yes	Yes
EDTV 576p	625/576p	Yes	No	Yes	Yes
HDTV 720p	1280x720	Yes	Yes	Yes	Yes
HDTV 1035i	1920x1035	Yes	Yes	Yes	Yes
HDTV 1080i	1920x1080	Yes	Yes	Yes	Yes
HDTV 1080p	1920x1080	Yes	Yes	Yes	Yes
HDTV 1080sF	1920x1080	Yes	Yes	Yes	Yes
HDTV 1080p	1920x1080	Yes	Yes	Yes	Yes
HDTV DCDM	2048x1080	No	Yes	No	No
VGA	640x480	Yes	No	Yes	Yes
800x480	800x480	Yes	No	Yes	Yes
WVGA	848x480	Yes	No	Yes	Yes
SVGA	800x600	Yes	No	Yes	Yes
1280x600	1280x600	Yes	No	Yes	Yes
720p RGB	1280x720	Yes	No	Yes	Yes
XGA	1024x768	Yes	No	Yes	Yes
WXGA	1280x768	Yes	No	Yes	Yes
SWXGA	1360x768	Yes	No	Yes	Yes

Standard	Size	HD-15	3G-SDI	HDMI	Single-Link DVI-D
1366x768	1366x768	Yes	No	Yes	Yes
800p RGB	1280x800	Yes	No	Yes	Yes
SWXGA+	1366x800	Yes	No	Yes	Yes
1152x864	1152x864	Yes	No	Yes	Yes
900p RGB	1440x900	Yes	No	Yes	Yes
1600x900	1600x900	Yes	No	Yes	Yes
960p RGB	1280x960	Yes	No	Yes	Yes
SXGA	1280x1024	Yes	No	Yes	Yes
1360x1024	1360x1024	Yes	No	Yes	Yes
DILA4/3	1364x1024	Yes	No	Yes	Yes
SXGA+	1400x1050	Yes	No	Yes	Yes
WSXGA+	1680x1050	Yes	No	Yes	Yes
1080p RGB	1920x1080	Yes ¹	No	Yes	Yes
2K	2048x1080	Yes ¹	No	Yes	Yes
Q WXGA	2048x1152	Yes ¹	No	Yes	Yes
UXGA	1600x1200	Yes ¹	No	Yes	Yes
WUXGA	1920x1200	Yes ¹	No	Yes	Yes

Note:

1) Reduced Blanking

4.7 Output specifications

4.7.1 Standard output

The **QuickVu** has two standard outputs.

The standard output contains:

- Analog Computer/Video (HD15),
- HDMI output over a DVI-I connector or DVI-I output (DVI-Analog and DVI-Digital).



VGA

DVI-I

Please see the formats available on the output:

Output Type	Format	Signal
Analog Computer	HDTV Computer	Analog HDTV Analog Computer
DVI-I Output	HDTV Computer	Digital HDTV Digital Computer

4.8 Communication specifications

4.8.1 Serial interface

A standard RS232 interface is available through a DB9 female connector:

- It permits controlling the device
- It permits updating the device

Data Rate: 1200 to 115200 Bauds, 8 data bits, 1 stop bit, no parity bit, no flow control by default.

DTR & RTS needed for firmware upgrade.

4.8.2 LAN interface

A standard LAN interface is available through a RJ-45 connector

- It permits controlling the device
- It permits transferring configuration
- It permits connectivity with the RCS² application
- It permits updating the device

4.8.2.1 Protocol

Protocol	Availability
TCP	Yes
UDP	Yes

4.8.2.2 IP address

Address allocation	Availability
Static user defined address	Yes

Default IP address: 192.168.2.140

4.9 Environmental specifications

Dimensions:

- ▶ D 15.75" x W 19" x H 3.46" with rack mount and handles
- ▶ D 400 mm x W 483 mm x H 88 mm
- ▶ D 14.17" x W 17.3" x H 3.46" without rack mount and handles
- ▶ D 360 mm x W 440 mm x H 88 mm

Weight:

- ▶ 6,3kg / 13.9 lb
(Compatible with a Standard 19" rack, Height = 2 U)

- Cooling air flows from right side to left side.
- Max ambient operating temperature: < 40°C (< 104°F).
- Operating temperature: 0 to +40°C / +32°F to +104°F
- Storage temperature: -40 to +70°C / -40°F to +158°F
- Operating humidity: 10 to 80% (non condensing)
- Input voltage range: 100-240 VAC autosensing, 50/60 Hz
- Typical consumption: 110 W

ELECTRICAL SECURITY:

- IEC 60950-1:2005 (2nd Edition); Am 1:2009
- EN 60950-1:2006 + A1:2010 + A11:2009 + A12:2011, CSA C22.2; National Differences specified in the CB Test Report
- UL listed (Canada & US)

ELECTROMAGNETIC COMPATIBILITY:

- IEC 61000-3-2 (2009)
- IEC 61000-3-3 (2008)
- CISPR22 (2008)
- CISPR24 (2010)
- FCC Part15 of 2012
- IECS-003 of August 2012

ENVIRONMENT:

- RoHS
- WEEE

USE/TRANSPORT:

- ETS 300 019-2-2: Environmental conditions and environmental tests for telecommunications equipment ; Part 2-2 : specification of environmental tests ; Transportation ; Specification T 2.3: Public transportation
- ETS 300 019-2-3: Environmental conditions and environmental tests for telecommunications equipment ; Part 2-3 : specification of environmental tests ; Stationary use at weather protected locations ; Specification T 3.1 and T 3.1 E: Temperature-controlled locations



If your device should lose power unexpectedly, you may lose any unsaved settings.

4.10 HDCP management

4.10.1 Input HDCP detection

The input HDCP detection is managed by the input components according to HDCP specification.

4.10.2 Output HDCP detection

The **QuickVu** manages the output HDCP detection according to one of the following criteria:

- Hot plug,
- 3-second period attempt.

4.10.3 Keys' checking

Keys' checking is performed according to the most restrictive condition among the 2 following ones:

- Every 2 seconds
- Every 128 frames

4.10.4 Output management

HDCP protected content can be displayed only on HDCP protected outputs or displays. Therefore, whenever an HDCP protected source is placed into a layer routed to a non-protected output, the **QuickVu** will not output the protected content on this non-protected output, and the layer will be grayed.

If possible, the **QuickVu** will allow to display all other non-protected contents, otherwise the entire output will be muted until the protected content is no longer routed.

4.10.5 HDCP Classification

Class	Support
HDCP Receiver	Yes
HDCP Transmitter	Yes
HDCP Repeater	No

HDCP Receiver

The HDCP negotiation can be enabled or disabled on all HDCP inputs.

HDCP Transmitter

The HDCP negotiation can be enabled or disabled on all HDCP outputs.

The **QuickVu** can manage HDCP repeaters on its outputs: up to 32 display devices can authenticate simultaneously on each output.

4.10.6 Status

In order to permit quick identification of all the HDCP operations on the device, the **QuickVu** provides a full set of status summary to help the user with the HDCP management:

- A front panel menu that displays all the general HDCP status of all inputs and outputs

5. CONNECTING THE QUICKVU

5.1 Description

5.1.1 Rear panel

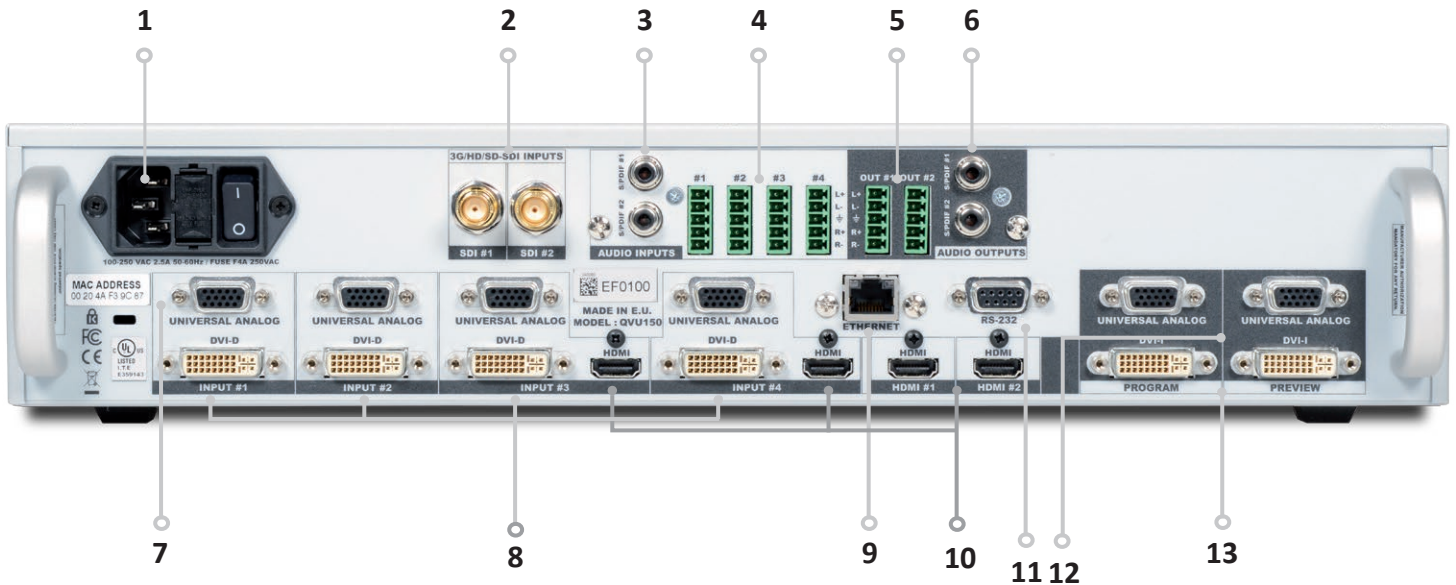

1. Power supply: 100-240 VAC 2.5A 50/60HZ / FUSE F4A 250 VAC; internal, autoswitchable; 110W

2. 3G/HD/SD-SDI: SDI #1 to #2

3. S/PDIF: audio inputs #1 to #2

4. MCO male connector: for audio inputs (balanced) #1 to #4

5. MCO male connector: for audio outputs (balanced) #1 to #2

6. S/PDIF: audio outputs #1 to #2

7. Universal Analog Computer TV/HDTV: inputs #1 to #4

8. DVI connectors: DVI-D inputs #1 to #4. Capability to receive digital audio signal from HDMI connector via an adaptor (HDMI-compatible)

9. Ethernet plug

10. HDMI connectors: HDMI inputs #3 & #4 / HDMI #1 & HDMI #2

11. Communication port: communication port with DB9 female connector

12. Universal Analog Computer TV/HDTV: HD15 outputs #1 to #2

13. DVI connectors: DVI-I outputs #1 to #2. Capability to transmit digital audio signal towards a HDMI connector via an adaptor (HDMI-compatible)

5.1.2 Front panel

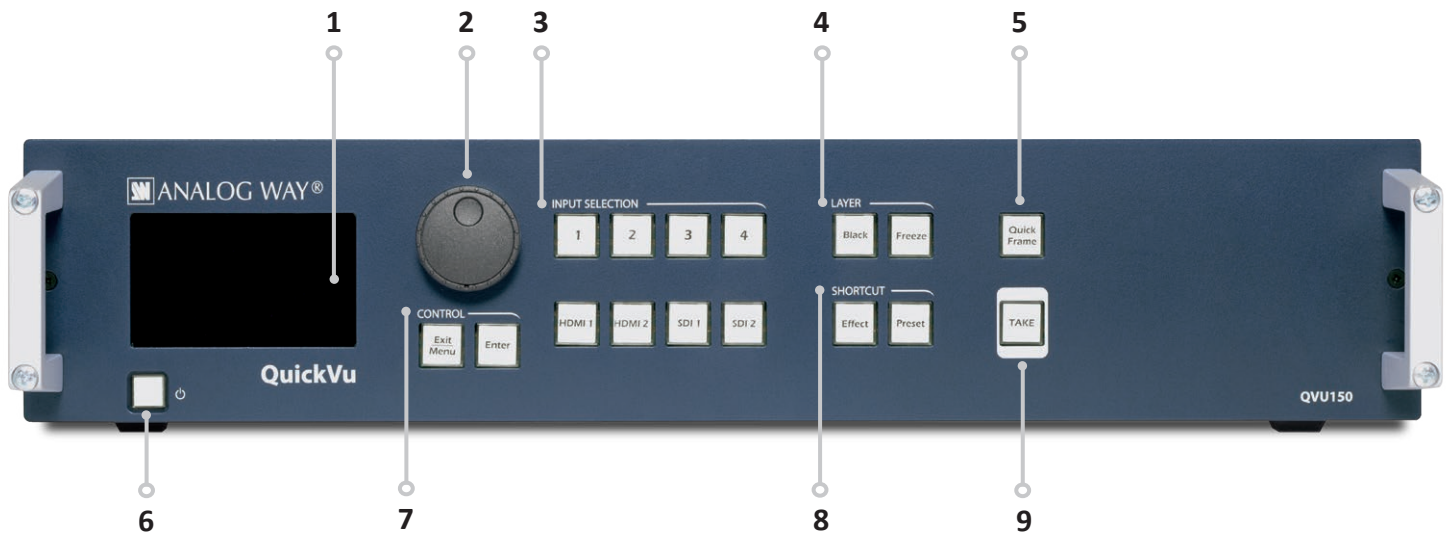

1. Front panel display: 4-line VFD

2. Menu scroll knob

3. Input selection:

- **1 to 4:** access source 1 to 4
- **HDMI 1/2:** access HDMI 1 or HDMI 2
- **SDI 1 to SDI 2:** access SDI 1 to SDI 2

4. Layer:

- **Black:** clear the layer
- **Freeze:** freeze/unfreeze the input selected in the currently selected layer

5. Quick Frame: allows to quickly display a foreground Frame

6. On/Off - Stand-by: hold for 3 seconds for stand-by mode

7. Control: **Exit/menu:** Home menu or back one level - **Enter:** validate the menu or command

8. Shortcut:

- **Effect:** shortcut to transition menu
- **Preset:** recall a custom stored preset

9. TAKE: transition the pre-selected sources onto the Program output with the selected effects

6. CONTROLLING THE QUICKVU

The **QuickVu** can be controlled and operated either via the Front Panel, from your computer via the RCS², or via one of our Event Controllers. (Control of the **QuickVu** can also be integrated into automation and control systems, contact your local technical support for more details.)

6.1 RCS² requirement

The recommended requirements are:

- Adobe Air®
- 1Gb Ram
- 200Mb of free space
- 100Mb Network adaptor or above
- 1920x1080 optimized screen resolution
- 1366x768 as the minimum screen resolution.

Operating system:

- Windows XP SP3 or above
- Mac OS v10.7 or above
- Ubuntu v10 or above
- Linux OS 11 or above

For Linux users:

The RCS² is an Adobe® AIR® application that requires the most recent version of this runtime. As Adobe® AIR® is no longer supported for desktop Linux distributions, please use a dedicated software such as WINE to use applications designed for Microsoft Windows on your operating system.

1. First, install a Microsoft Windows compatibility layer software on your Linux PC.
2. Then install the Adobe® AIR® last release using your emulator
3. Finally, install the RCS² using your emulator.

You are ready to use the RCS².

6.2 Connecting with the RCS²



The RCS² is an Adobe Air application that runs on your computer. Before you can connect to your device, you must first download and install Adobe Air, then download and install the RCS² on your computer.

In order to connect the RCS² to the device, you need to use a LAN connection. Use a crossover cable if you connect your computer directly to the unit, or use straight cables if you are connecting through a switch or hub.

Before switching ON the unit, please plug a LAN cable on the rear panel into the Ethernet port. Then switch ON the unit.

By default, the network settings on the **QuickVu** are

Default IP Address: 192.168.2.140

Default Subnet Mask: 255.255.255.0

Default port: 10500

To be able to connect to this address, your computer will need to be configured to use a unique IP address on the same network. If this setup will be part of a larger network with other devices, please check with your network administrator before plugging these devices into the network to avoid any IP address conflicts.

For example, you could assign the following static IP address to your computer:

Example Computer IP address: 192.168.2.50

Example Computer Subnet Mask: 255.255.255.0

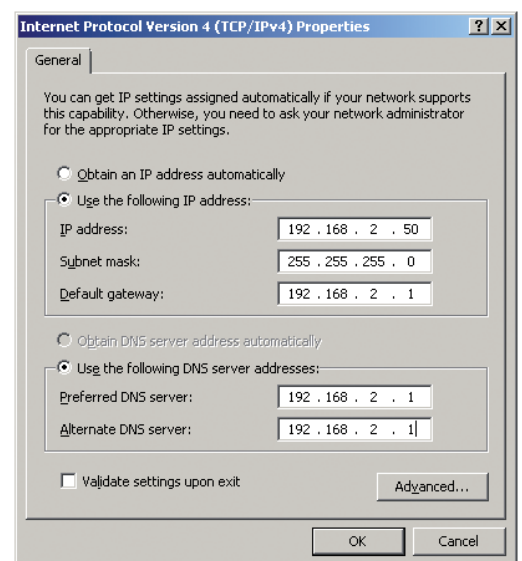

To download the Remote Control Software, please visit our website and go into the product section. Then, into the download link, please download the RCS² associated to your product. Install it and then open. Here is the startup screen.

Enter the IP address of the device and then the remote port.
Click on **SET AS DEFAULT** if you want the software to remember your configuration.
Click on **Connect** to start the connection.



Once connected, you have access to this screen:

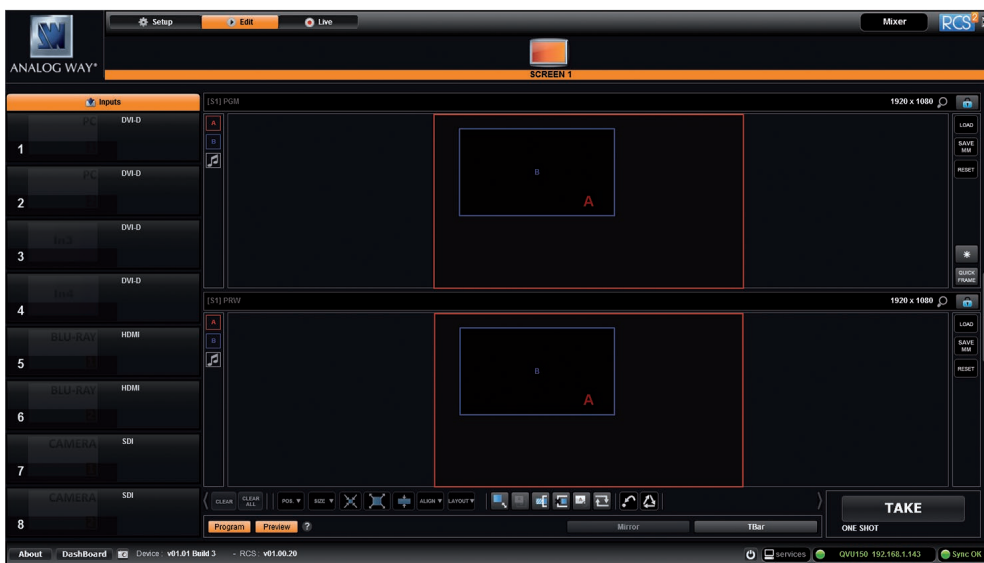

In case of difficulties:

- Verify that you are using the correct network cable and that it is free from defects. (Crossover or straight cable as required.)
- Check the IP address of both the device and the computer. It must have a unique IP address on the same network as your **QuickVu**. You may need to manually configure a static IP address for your computer in your computer's network configuration.
- You may need to temporarily disable any other networks on the computer, such as turning off the wifi connection.
- Close the RCS².
- Restart the RCS².

Once your computer has established connection, the RCS² control panel will begin to load, and will begin to synchronize with the device. When the small "Sync" icon at the bottom right of the display has turned green, the RCS² software is ready to use.



Some computers use an energy saving mode that turns off the network adaptor during periods of inactivity. To avoid the inconvenience of reconnecting the software during use, please ensure your network adaptor remains active by disabling the energy saving mode.

6.3 RCS² top menu



6.3.1 Setup

The Setup page is where you will review and modify the device configuration, such as output resolutions, input settings, and more.

6.3.2 Edit

The Edit mode is the place where you will manage preset creation. You will make input selections, manage your inputs, adjust the layer attributes such as size, position, effect, etc. You can save your screen configurations into presets, as well as review and recall them on Preview or Program.

6.3.3 Live

The Live mode is the section where you will operate your show. You can quickly recall presets or make input selections, as well as setup a sequence of presets that can run continuously with custom durations, or wait for user interaction.

7. OPERATING THE QUICKVU FROM THE RCS²

7.1 Operating mode

Before you start setting up your **QuickVu** for the first time, take some time to think about how you will be using it. The **QuickVu** offers one operating mode, which results in a versatile video production tool for live event staging and fixed installation applications.

NOTE: We recommend resetting the device to its default values every time you set up your shows or events.

7.2 Setup

Go to the setup section to start to set up your unit. A Setup assistant is available to help you to correctly adjust all basic setups of your unit.



7.2.1 Mode

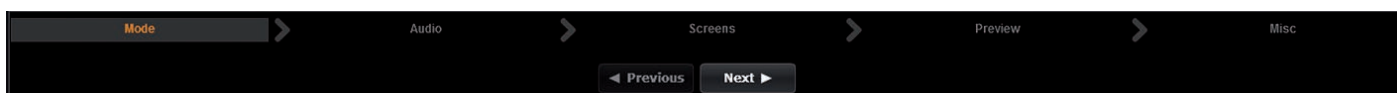

The device can only work in 1 mode: Mixer mode.

Mixer mode

This mode allows for a single **QuickVu** to seamlessly switch any of its 8 analog/digital inputs with any other of the inputs, add PIP with titling to the live frame, while previewing your every move before going live, to avoid embarrassing errors on your main screen.

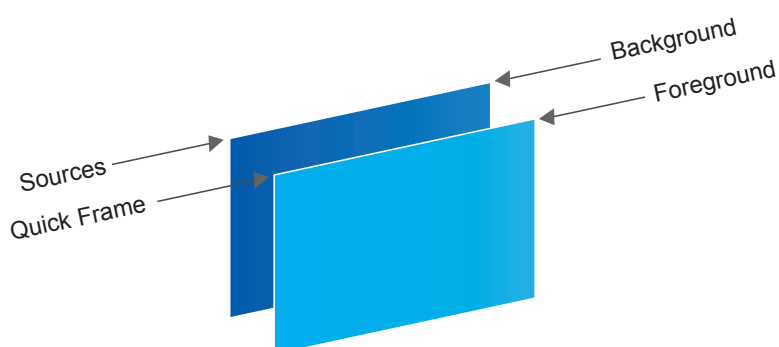

7.2.2 Audio

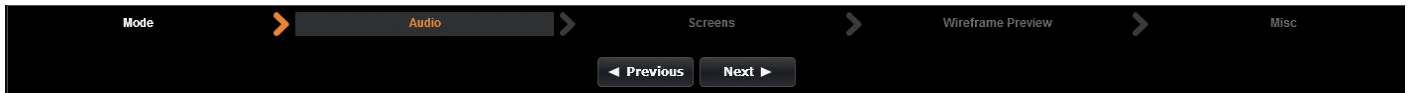

In this section, you will setup the audio of your device, you have several modes. In all modes, you have the possibility to output the audio in AES3 or SPDIF:

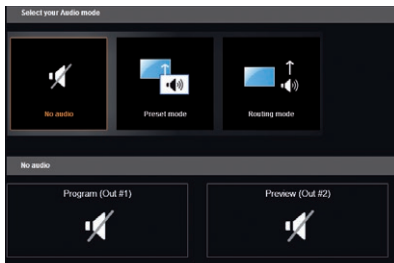

NO AUDIO: the audio of your device is switched off

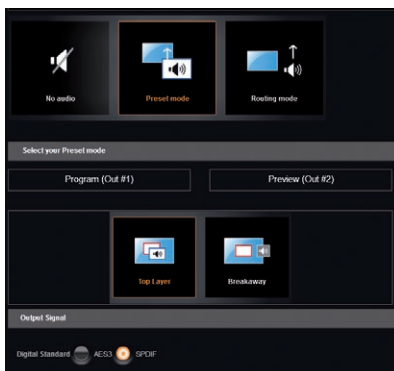

PRESET MODE: the standard mode of use of the device

You have two possibilities:

- **Top layer:** the sound on the output will follow the audio input of the top layer.
- **Breakaway:** when breakaway is activated, the audio on the output is memorized into the preset. A change of preset, changes the audio on the output. A change of content into a video layer has no effect on the audio.

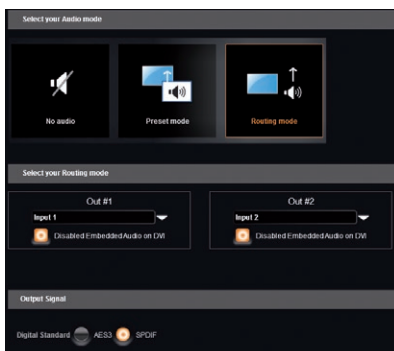

ROUTING MODE: in this configuration, simply choose an audio input to assign it to the output. The audio configuration remains the same during the show.

In this example input1 is on out1 and input 2 is on out 2.

7.2.3 Screens

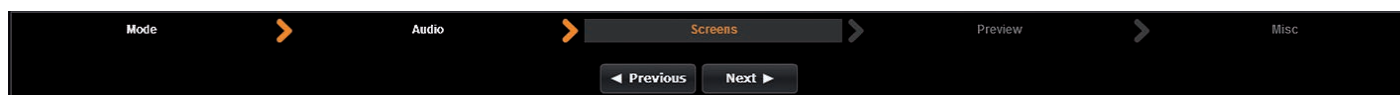

In the screen configuration, you will find the state of your screen. It indicates the screen resolution, the maximum number of layers you can use.

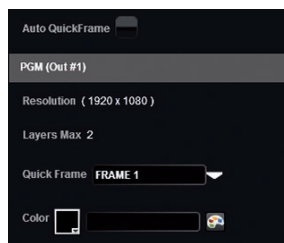

You will find configuration for the Quick Frame and the background color too. The Quick Frame will be your emergency frame that can be displayed in front of every layer. Here, select the frame slot number to be displayed as the Quick Frame.

7.2.4 Preview

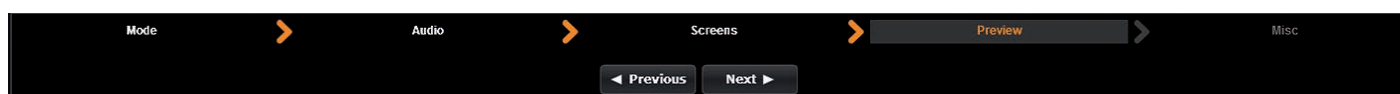

Into the PREVIEW section, you have the possibility to enable or not the PREVIEW aspect.

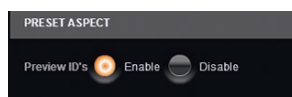

PRESET ASPECT: disabling this option disable the Preview indications on your Preview monitor, such as the blinking layer wireframe, and source number.

7.2.5 Misc

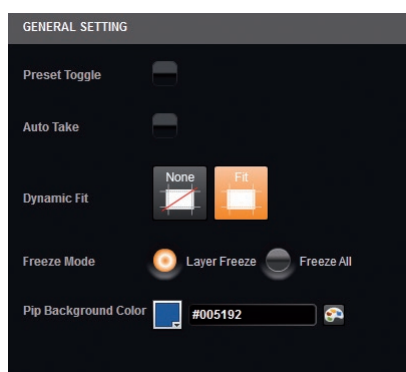
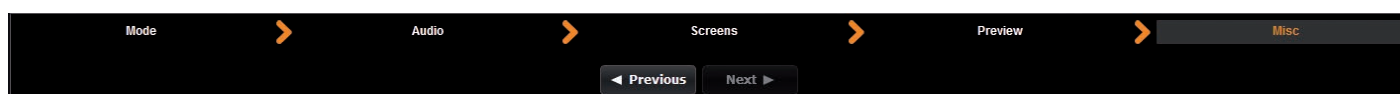

PRESET TOGGLE: by default, the device will not swap the Program and Preview busses during each TAKE. Disabling this option will leave the Preview bus unchanged during each TAKE, and only the Program will be updated. When this option is enabled, the Preview and Program busses will be swapped during each TAKE.

AUTOTAKE: enable the automatic TAKE. Each time a source is changed on preview, it triggers a TAKE to be launched.

DYNAMIC FIT: enable or disable the automatic recognition of black band for digital content. The size and the aspect ratio of the layer are automatically adapted.

FREEZE MODE: choose to freeze all inputs or only one input when you use the freeze function.

PIP BACKGROUND COLOR: here you chose the automatic color of PIP background, black is the default color.

7.2.6 Output management

Into the output section, you will be able to manage your output resolutions, formats, sync types, test patterns, etc. On the **SETUP > OUTPUT TAB**, the following screen will appear:

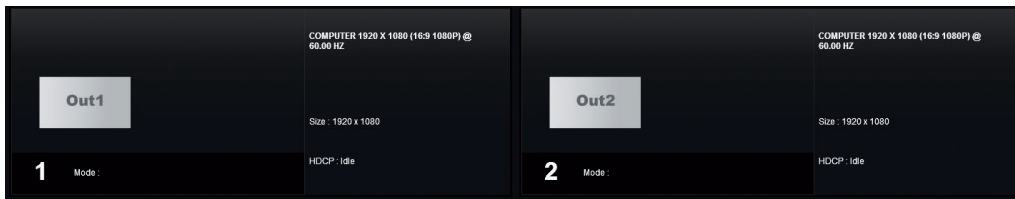

A short summary of each output settings appears on the main page. You can see the number of outputs, their resolution, rate and HDCP status.

Select an output to adjust by either clicking on it from the column on the left, or clicking the configuration cog icon for that output.

Once the individual output setup page is opened, you have access to:

- **MODE:** choose your rate generation mode, internal (free-running within the unit) or Framelock by choosing an input as a reference input,
- **FORMAT:** choose the output resolution format,
- **RATE:** choose the signal timing standards, if the mode is set to internal
- **STATUS:** the status menu will show you the current output status,
- **APPLY:** click on this button to apply the new format/rate,
- **PLUG STATUS:** indicates the status of the attached monitor and confirms connectivity,
- **TYPE:** you can choose the type of output synchronization on the analog plug, for example RGsB for sync on green, or RGBHV for separate H and V sync wires,
- **FORCE DVI MODE:** select this box to force the output to DVI mode instead of the default HDMI autosense mode. When in DVI mode, no embedded audio will be transmitted,
- **PATTERN:** a selection of patterns is available to test your output. These patterns will override any input selection that you might have.

You can choose from:

- **No Pattern** – turns the pattern off
 - **Vertical or horizontal Grey Bars** – displays grey bars
 - **Vertical or horizontal Color Bars** – displays color bars
 - **Grid** – displays an 8x8 box grid pattern
 - **SMPTE bars** – displays the SMPTE color bar pattern
 - **Vertical Burst** – displays alternating black and white 1 pixel wide columns
 - **Vertical or horizontal gradient** – displays a 0 to 100% gradient pattern
 - **Centering** – displays a 1 pixel wide dotted line at the edge of the output (only available for computer formats).
- **FLICKER:** choose the value of the flicker filter to remove the flicker effect on your interlaced output screen,
 - **GAMMA:** increase or decrease the gamma of your output,
 - **HDCP:** enable/disable and see the HDCP status.

Depending on the output format chosen, only relevant settings will appear.

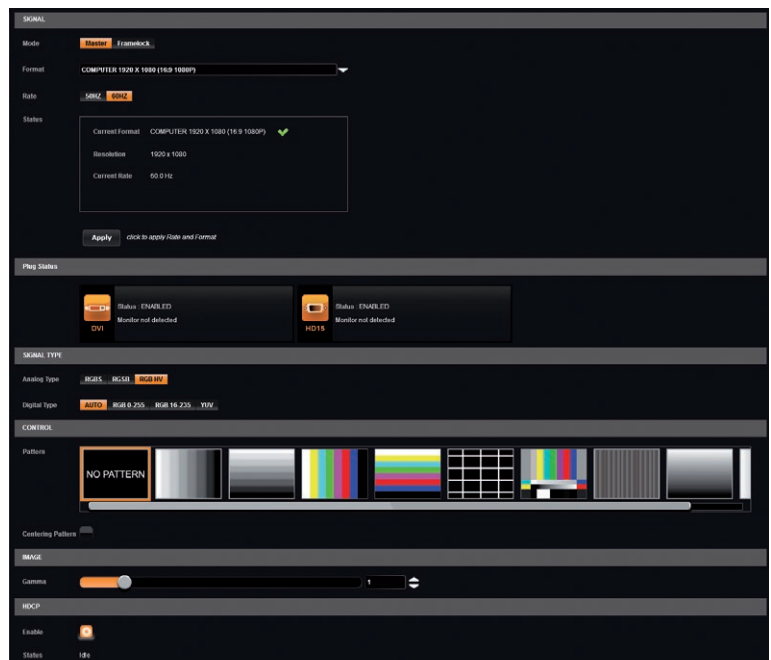

Custom format

The device offers the possibility to create your own output format:



Choose CVT mode (restricted settings) or FULL mode (full settings) and start to create your format by adjusting the Horizontal Vertical pixels, frame rates and reduced blanking.

Click on CHECK to verify if your format is a valid signal. You can SAVE and LOAD your Custom format.

7.2.7 Input management

Once your outputs are configured, you have now to configure the inputs connected to your device.

Under the inputs section, you can view your inputs **by active plugs** or **by all plugs** (active and inactive).

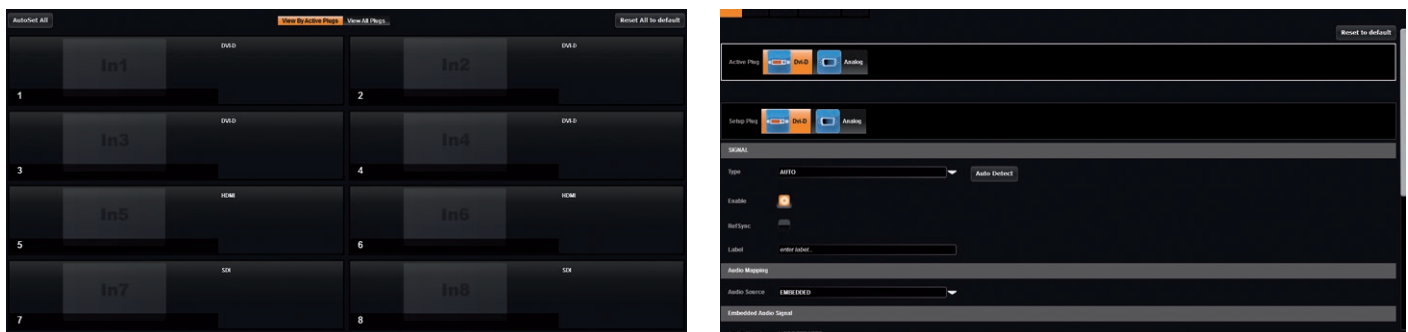

In both cases, an **AUTOSET ALL** can be launched to set up automatically your inputs.

Once the **AUTOSET ALL** is done, you can check one by one your inputs and see if they were correctly detected by checking the input **STATUS**. The input **STATUS** is defined by a **FORMAT** and a **RATE**. If that information is not available, your input has not been properly detected or set up.

In this case, you can enter manually into each input settings by using the left menu:

Under the **SIGNAL** tab, you will find:

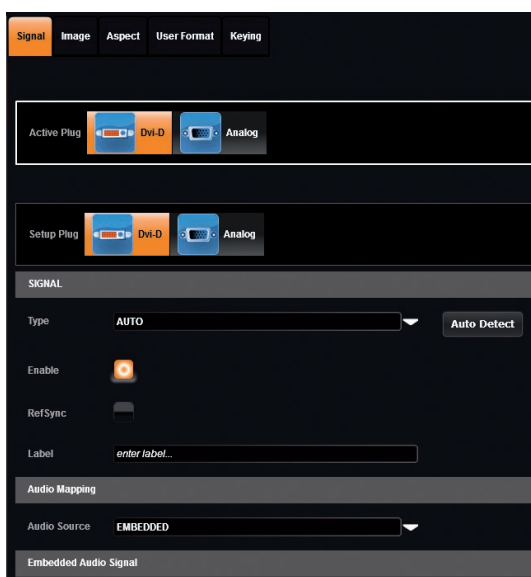

- **ACTIVE PLUG:** select the plug used by the unit at the moment. Only this plug can be displayed on your output,
- **SETUP PLUG:** select the plug you want to set up, all changes will be applied to this plug, even if this plug is active or not (do not mismatch with the active plug),
- **SIGNAL TYPE:** define the type of your signal, video SD/HD YUV/RGB or Computer HV/SOG etc.,
- **ENABLE:** enable/disable the input,
- **REF SYNC:** affect the input to the ref sync input. Use this box only if your source is genlocked with the referenced source (framelock feature),
- **LABEL:** rename your input according to your source,
- **AUDIO MAPPING:** select the audio input that will be linked with the video input,
- **EMBEDDED SIGNAL AUDIO:** status indicates if an embedded audio signal is detected or not,

- **STATUS:** format and size of the input,
- **CONTROL:** **Black:** select Black to transform your input in a uniform color (black),
Freeze: use this button to freeze the specific input,
- **EDID:** choose the EDID for the selected plug.

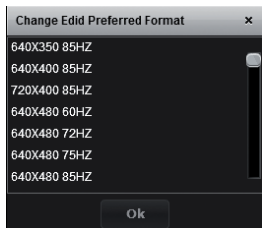

Under the **HDCP** section, you can:

- Enable/disable the HDCP communication feature
- Read the HDCP status, If the HDCP status says Active, this output connection is currently utilizing HDCP to protect the signal. if the HDCP status indicates Idle, this output connection is currently not utilizing HDCP.

Next is the **IMAGE** tab, where you can find all settings about the display of your input:

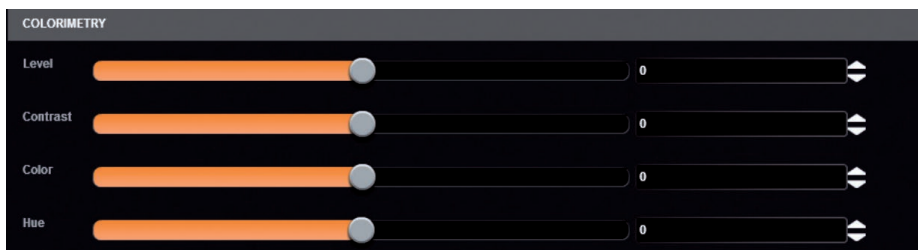

Under the **COLORIMETRY** section, you have:

- **LEVEL:** define the selected input luminosity level,
- **CONTRAST:** define the selected input contrast level,
- **COLOR:** define the selected input color level (0:black and white, full: full color),
- **HUE:** set up the hue phase of your NTSC signal.



Under the **USER GAIN** section, you find:

- **THE RED/GREEN/BLUE:** increase/decrease the Red/Green/Blue level of your input.

Next you have the **ASPECT** tab. All settings about the blanking and aspect ratio are available there:

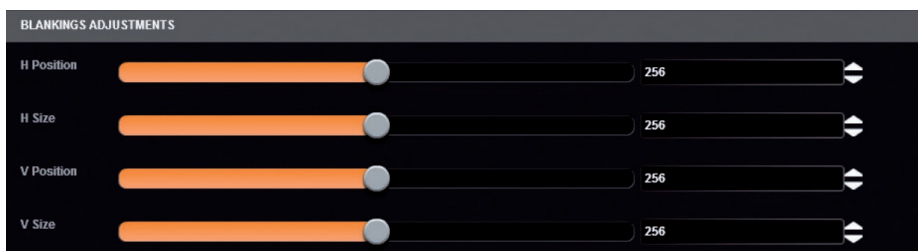

Under the **BLANKING ADJUSTEMENTS:**

- **H&V POSITION SIZE:** you can manually adjust the input blanking with the V&H size or position.

Under the **ASPECT RATIO** section:

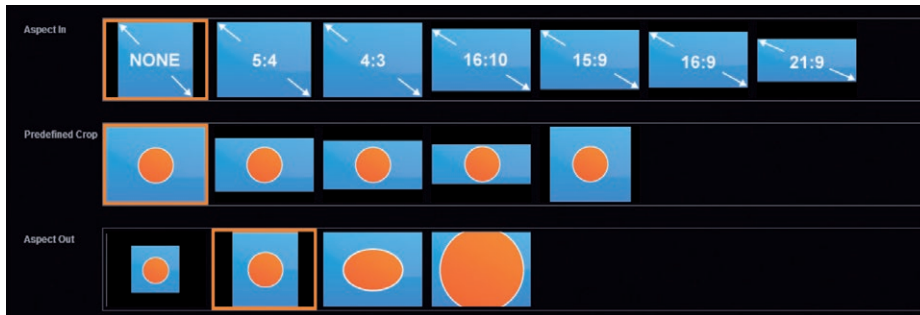

- **ASPECT IN:** forces a particular aspect ratio for the source. (5:4, 4:3, etc). This setting has no effect when set to native,
- **PREDEFINED CROP:** choose a specific cropped ratio if you use a source with black bands on top/bottom or left/right,
- **ASPECT OUT:** define the way the image will be displayed into a layer (full screen, centered, cropped or 1:1),
- **OVERSCAN:** choose to apply or not a predefined zoom on the image (use with video signal).

Next settings available on the **ASPECT** tab are:



- **CROP:** use the Top, Bottom, Left and Right values to crop your input.

The next tab is the **USER FORMAT:**

In this tab, you can explicitly define the input format. The input format is automatically detected by the **QuickVu** but you can change it or force it. The available formats are close to the current one, in terms of lines. This is only available for analog computer formats.

Keying Feature

With the keying feature, you will be able to key easily a color space or a specific luma on an input.

The device offers an individual keying for each input. Into the input settings, find the keying menu: You have 2 ways of using the keying:

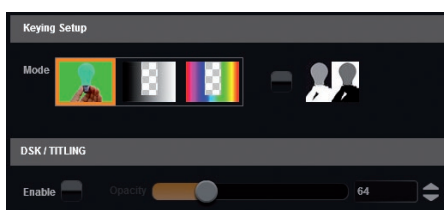

- **COLORKILLER:** classic color keyer removing a specific color space defined by user,
- **LUMAKILLER:** luma keyer removing a specific lumanance level range.

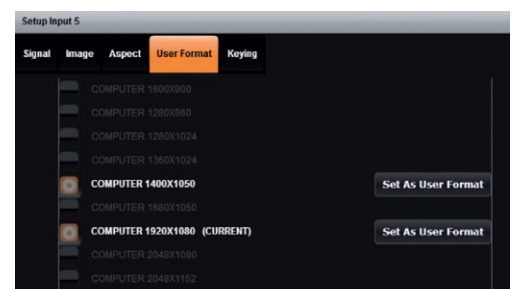

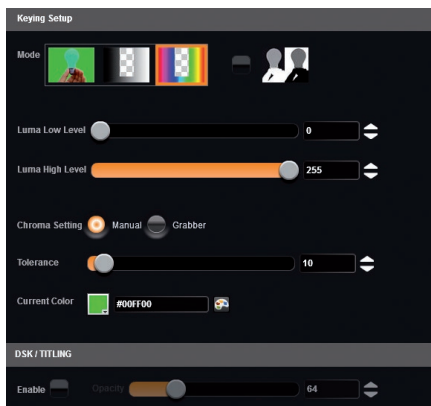

Keying setup can be done either by setting directly color references and tolerances or by using the color grab assistant.



- **INVERT BUTTON:** at any time you can choose to invert the actual keying using this button.

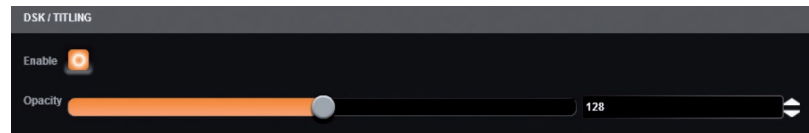

DSK TITLING: after your keying, the DSK titling feature allows you to play with the transparency of your deleted pixels. Enabling this, simply adjust the opacity settings to make your keyed pixels less or more dark. This is useful when keying white or light colored text over a bright background.

How to use the **LUMA KEY:**

Select the lumakiller and then adjust manually, the luma level:



- **Manually:** set the minimum luminance value.

Luma Low Level: Everything darker than this value will be keyed away.

Luma High Level: Everything brighter than this value will be keyed away.

Then adjust the maximum luminance value to define the range of luminance levels which will be deleted.

Once you have completed the setup of your keyed input, place it in layer B on top of your background (such as a camera in layer A) in order to complete the keyed title or lower third effect.

How to use the **CHROMA KEY:**

- **Manually:** set the Hue and luminance to choose the color space you want to delete into your image.

Set it manually looking at the color change into Current color. If you want, you can quickly select a color from a color panel, clicking on **CURRENT COLOR**. Then click on the color itself to obtain the color panel. Once your main color is chosen, you can define a degree of tolerance around this color. The tolerance will define, around the main color, an area that will be keyed too. You may still need to make further adjustments to the luminance level to complete your key effect.

- **Grabber:** activate the grabber to grab the color you want to key. Move the cursor and click on the grab button to grab the color.

7.2.8 Frame management

To save a frame click on this button:

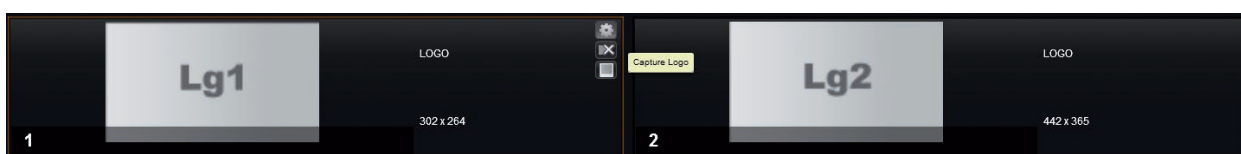

The next page opens.

From here you can capture from the main or from the Preview.

You can still freeze the output before saving your frame.

How to save a frame:

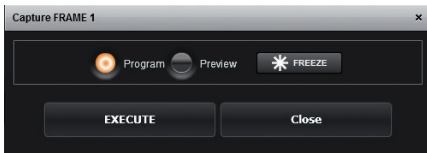

Choose first Program or Preview, click on **FREEZE** if you want to freeze your output. Then click on **EXECUTE** to save your frame into the selected slot.

7.2.9 Audio management

The audio section permits the management of level, balance, and other audio settings for each input.



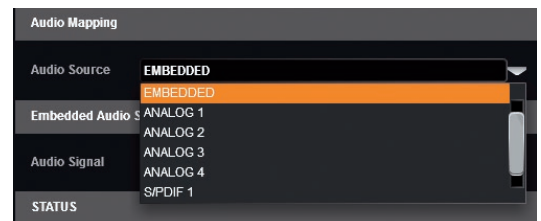

Before modifying the audio settings, be sure to check the audio input mapping. Each video input has one audio source mapped to it. The audio mapping configuration is found under **Menu > Inputs > each input**.

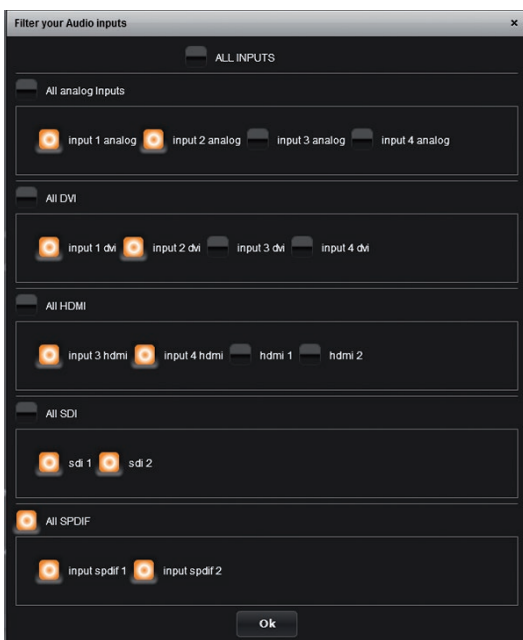

Into the **AUDIO SETTINGS**:

To display only the Current audio input which is played, click on **Current** button. only Current



If you want to select which audio input will be displayed, click on the list button  then select the input audio source you want.



To setup your analog audio input, simply click on **“ON PRELIST”**, if you have a Preview output, the audio input will be played on it. Then adjust the **GAIN** from **-11 to +6dB**.

A red indicator light will be displayed if you reach the input clip. If the input clip light is being illuminated, it means that the input gain is too high and the signal is being distorted. To solve this issue, decrease the gain value. The **0dB** corresponds to a **+4dBu** signal in input.

The gain manual adjustment is only available for analog input.

For every input, you have the possibility to set up your source as a mono audio or stereo audio source.

You have the possibility to adjust the level vs right level using the Pan knob.

All input still have their own level which is **0 by default**, decrease or increase the value to modify the sound level:



Specific feature:

- **DIGITAL SOURCE:** all digital sources will have their sample rate displayed,
- **SDI SOURCE:** on SDI source you can choose 2 channels on one of the 4 groups.



The available audio output controls depend on the device setup configuration. If you are in a program/preview mode, you will have program/preview audio outputs.

For the audio output, you will find:

- **A LEFT/RIGHT PAN ADJUSTMENT**
- **A GAIN ADJUSTMENT:** this setting will help you to calibrate the analog audio output component. Depending on the device you will use after the analog way device, adjust carefully the analog gain. Basically, for a 0 level, the default value is 4 dBu.
- **A MASTER LEVEL:** it indicates the level of your input. On its right, a bar will move up and down to indicate the audio level in real time. A red button will turn on if the maximum level is reached.
- **A DELAY ADJUSTMENT:** the delay can be automatically calculated or manually adjusted. To adjust it manually, first disable the *Auto* button.

7.2.10 Service management

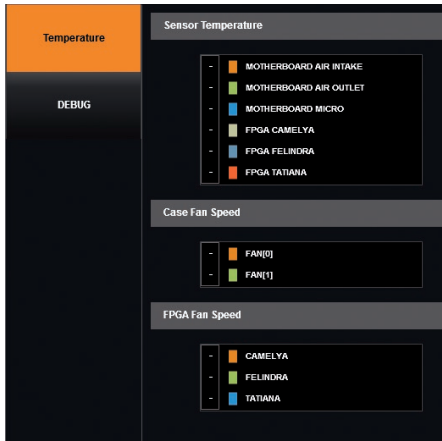

Into the service section, you will find tools to warn you if the unit has a problem.

Under **TEMPERATURE**, there is the alarm tab. If any fan FPGA or board are faulty, it will be displayed.

CARDS								
Name	Id	Serial	Mandatory	Ref	DateCode	Rev	IsPlug	
MOTHERBOARD	0x0	0	0	0	0	1	1	
CF CAMELYA	0x0	0	0	0	0	1	1	
CF FELINDRA	0x0	0	0	0	0	1	1	
CF TATIANA	0x0	0	0	0	0	1	1	
CF AUDIO	0x0	0	0	0	0	1	1	
CF FAW	0x0	0	0	0	0	1	1	
CF VIDEO OUT	0x0	0	0	0	0	1	1	
CF SDI IN 1	0x0	0	0	0	0	1	1	
CF SDI IN 2	0x0	0	0	0	0	1	1	
XPORT	0x0	0	0	0	0	1	1	

TECHNICAL SUPPORT: Display the different technical support contacts depending on your area.

7.2.11 Control management

In this menu, all specific settings, which cannot be sorted under the other menus, are listed:

Network

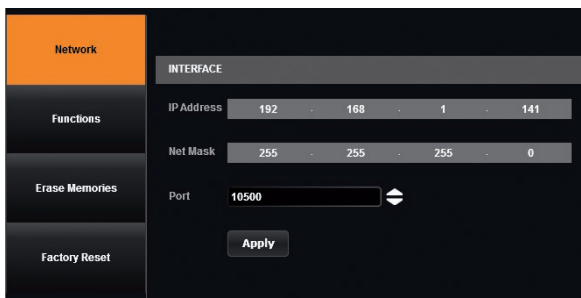

The interface loaded into the unit uses the IP configuration.

Under **INTERFACE**, you can define a new:

- IP address
- Netmask
- Gateway
- Port: choose the port
- Protocol: choose TCP (by default) or UDP

Functions

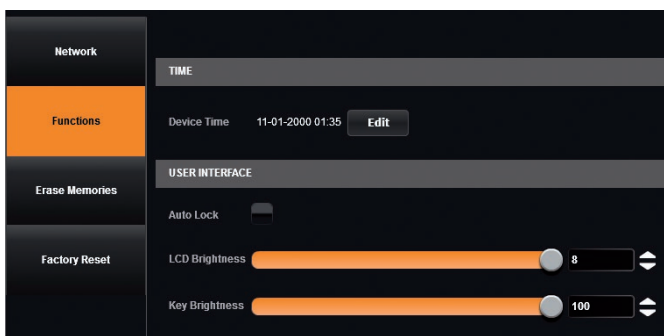

Under function, you can edit:

- **TIME:** the internal real time clock,
- **AUTO LOCK:** when this feature is enabled, you will be locked out from selecting empty inputs that have no source connected,
- **LCD BRIGHTNESS:** adjust the brightness of your LCD,
- **KEY BRIGHTNESS:** adjust the brightness of your keyboard.

Erase memories

Into this section, you can erase individual settings.

- Erase input settings memory: all input settings will return to their default value. This includes image, aspect, user format and keying parameters.
- Erase thumbnail: all the thumbnails you store on your computer will be erased.

Factory reset

Click on start to erase all settings (except network and RCS² parameters). The unit will reboot itself after the factory reset.

7.3 Edit

7.3.1 Layer management

When you enter into the Edit menu, you will encounter by default this window. On this example, we have the Screen 1 Program and the Screen 1 Preview. The following example can be applied for any other output configurations.

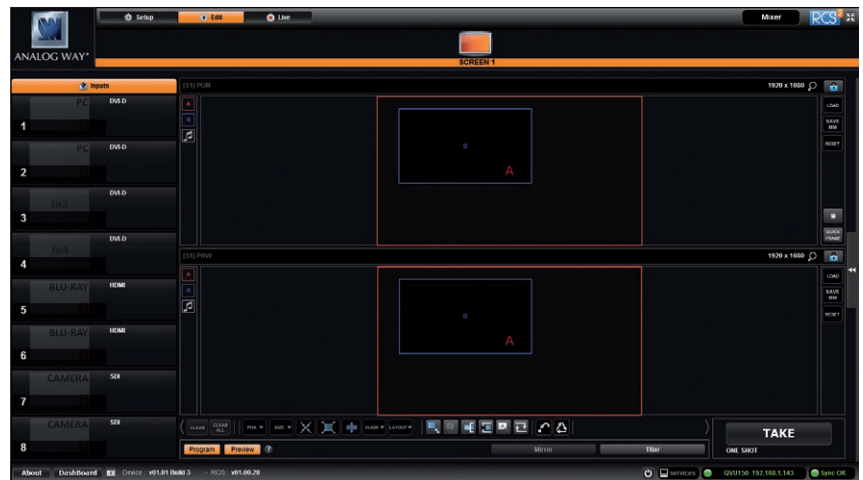

To display an input into one of the available layers A or B, simply drag and drop the input from the left column to the layer on the chosen screen. You can assign or change the inputs directly on Program as well as Preview.

Note: The layer B will always activate the keying feature on the source attached. Go into image settings to set up the keying.

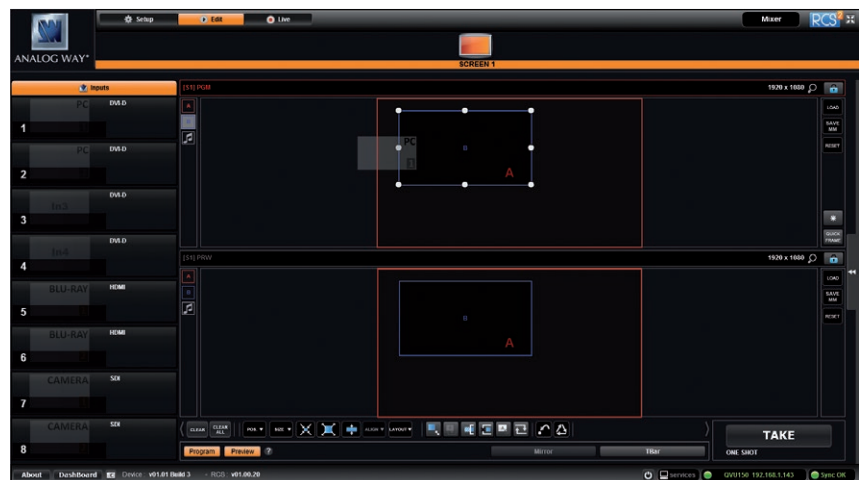

To display a logo, open the frame list column (next to the source list) and then drag and drop the desired frame onto the frame layer.

You can assign a source to a layer by dropping the selected source into the layer letter icon, located on the left side of the layout window. This is particularly useful when the desired layer is hidden or blocked by other layers.

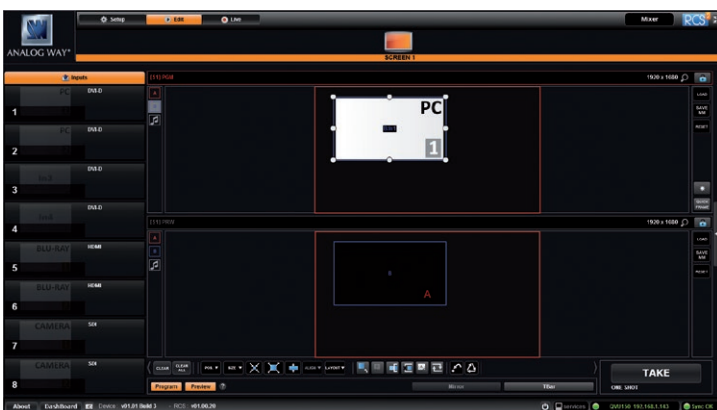

When a layer contains an input and is not empty, the RCS² displays the input number or a customizable thumbnail icon that represents your input. Please note: this thumbnail is not a live image.

In this example, 2 inputs are affected to 2 layers into the Screen 1 Preview. The **TAKE** button on the bottom right side allows sending your configuration, made on the Preview screen, to the Program screen.

With each press of the **TAKE** button, the Preview screen is transitioned to the Program screen. By default, **PRESET TOGGLE** mode is disabled. That means, after a **TAKE**, the Preview stays as it was before. The Program and Preview will have the same content.

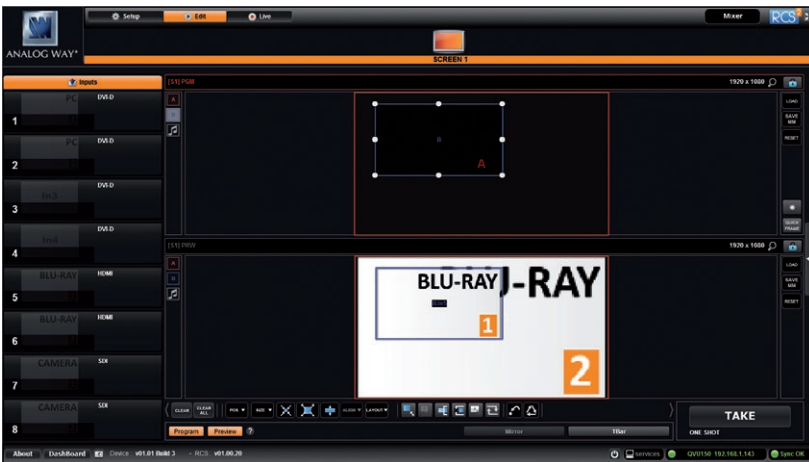

if desired, you can activate the **PRESET TOGGLE** mode from the **SETUP > PRECONFIG > MISC** menu, which will automatically swaps preview and program with each **TAKE**. After each **TAKE**, the Preview is reloaded with the previous Program.

Layers management

In this Edit mode, you have access to a lot of preset tools that can help you to create the preset you imagined.

7.3.2 Layer adjustments

The layer properties are found by opening the tab on the right side of the screen. Click on the double arrow button on the right to show or hide the layer adjustment tab.



Selected layer

The selected layer status information will indicate which screen, layer and source assigned to that layer are selected. You must select a layer in order to see the layer properties menu for that layer.

Reset feature

You can reset each category of layer settings quickly (Pos/Size, Transparency, Cropping, Transitions, Effects, Timing) or you can choose to reset every settings in one click using the **ALL** button. You can freeze the input assigned to the selected layer using the Freeze button.

The settings reset here only affects the selected layer on the selected preset. For example, you can reset the layer settings for layer A on Preview, and Program will be unaffected until you press **TAKE**.

Position/Size

Adjust the size horizontally (X) or vertically (Y), then adjust the width and the height of your layer. You can use the cursor or directly enter a value. To keep the aspect ratio by using the cursor, please enable the **KEEP ASPECT RATIO** button. You will find it on the right of the width and height cursors.

Transparency

Use the Transparency to give at your layer a transparent effect. Layers behind the transparency layer will show through more or less based on the transparency value.

Cropping (only for live layers)

The Cropping feature allows you to cut the part of the image you don't want. Simply adjust the size horizontally or vertically and then adjust the position to display only the desired content. This crop is a layer property, all inputs displayed in this layer will be cropped. Do not confuse this setting with the input crop which is specific to an input.

Transitions

On the Transitions section, you can filter which transitions you want to see. For Example, you can show just the Slide, Wipe transitions.

Each layer has an opening and a closing transition. The opening effect will be applied when the layer switch from a source to another source or when the layer is switching from empty and appears with a source.

To set up the duration of the transition, please see below the timing and duration settings. If you want to force the layer to perform a closing and opening transition, see **FORCE TRANSITION**.

7.3.3 Effects

Force transition

The Force Transition button disables the cross-transition between two sources into the same layers. Enabling the Force Transition, it forces the layer to go out and then go in with the desired effect instead of mixing directly the two sources.

Smooth Move

Enable the Smooth Move to perform a smooth transition on the layer. Disable the smooth move if you require a constant speed move.

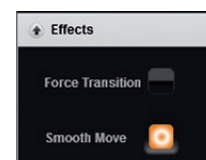

Layer layout



The layer layout gives you access to several predefined layouts with 2 or 1 layers already sized and placed into the output.

Once clicking on the layout button, you have access to the presets with 2, 1 layers or all layouts.

Two other options are available below:

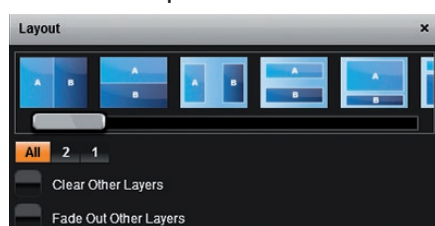

- **Clear other layers:** layers already displayed and not included into the chosen layout will be cleared
- **Fade out other layers:** layers already displayed and not included into the chosen layout will be faded out during the transition. They are still present on the preset but with a 100% transparency.

After selecting the layout, the changes are applied on the selected screen. The size and position of all layers are updated. After applying a layout template, you can make further modifications to the layers before Taking your selections to Program.

Layer position



A layer position shortcut is also available. After having selected a layer, simply click on the **Pos.** button to have quick access to a layer position. Choose the new position. The change is applied straight away on your preset.

Layer size



You can choose between several aspect ratios. Once selected, the new aspect ratio is applied on the selected layer.



Other layer adjustments:

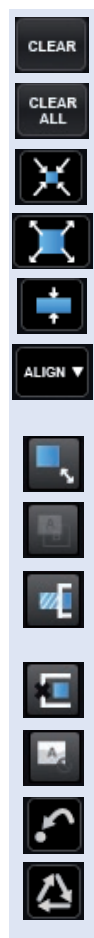

- **CLEAR BUTTON:** this button allows you to clear the selected layer from your preset,
- **CLEAR ALL BUTTON:** remove all layers from your preset,
- **CONTENT SIZE:** set layer size to its content size,
- **SCREEN SIZE:** set layer size to screen size,
- **LAYER SIZE/SOURCE RATIO:** set the layer size to fit the source ratio,
- **ALIGN BUTTON:** you need first to select at least 2 layers, then you can align them horizontally or vertically (use Shift to select 2 layers),
- **KEEP ASPECT RATIO BUTTON:** enabling this feature will keep the layer aspect ratio during resizing,
- **WIREFRAME MODE:** allows to enable/disable the layer thumbnails on your RCS²,
- **SHOW LAYER OUT OF SCREEN:** enable/disable the possibility to display a layer out of the screen into the RCS²,
- **TRAP LAYERS ON SCREEN:** disable the ability to position the layer off of the screen,
- **HIDE UNUSED LAYERS:** empty layers will not be displayed in the RCS²,
- **RELOAD PROGRAM:** load the preset of the Program screen into the Preview screen,
- **STEP BACK:** return to the configuration you had before the last TAKE,

7.3.4 Preset load and save management

Save a preset



Once your preset is set up, you can store it into one of the 64 preset slots. To do that, click on **SAVE MM** and choose the number corresponding to the slot number.

The first 8 presets are stored into the unit, all the other presets are stored locally on your computer, and will only be available when using the RCS² software.

If you want to have more details, you can **SHIFT+CLICK** on any preset to bring up a detailed status window. In this window, you can rename each preset using the **PRESET LABEL**.



- The first icon displays a window with all preset detail,
- The second one allows you to let the windows open,
- The last one quits the window.

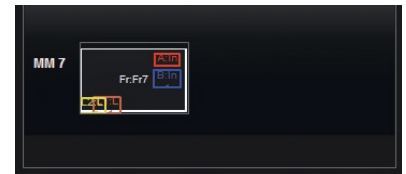
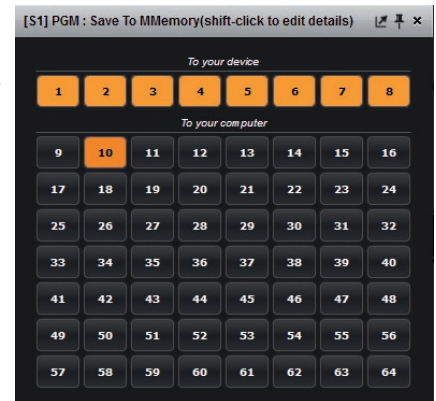

Load a preset



To recall a previously saved preset, click the Load button (on the right side of each screen) and select a preset to load.

Reset button



You can reset a screen using the reset button. Using that, all sizes and positions will be deleted. Your layers will be reset. If the «**HIDE UNUSED LAYERS**» button is enabled and all of your layers are empty and hidden, you can still access the layers using the layer icons on the left side of each screen.

7.4 Live

The Live mode is designed for easy live operation of the device after you have created some presets.



On the right, you will find all your saved presets under the tab called “**MASTER MEMORIES**”. A simple drag and drop on the screen will load your preset into the screen (Program or Preview).

If you want to change an input into your preset into the live mode, simply use the left source ribbon and drag and drop your input into a layer.

You can still use the load master memory to load a master memory from the memory of the device or the RCS² using the preset tables.

Please click on **SAVE MASTER MEMORIES** and then choose a number to save the current preset of the unit into a master memory.

You can load at any moment a frame in the same way into a frame layer.

To activate the **QUICK FRAME**, simply press the Quick Frame button (located on the right side of each screen).

Remember that a preset saved into a screen with a 1024x768 resolution, will keep its size into a screen of higher resolution. Therefore, it is best to save preset memories only after you have configured the output resolution.

You still have access to the **LOAD/SAVE/RESET** preset feature.

Once your preset is ready to send, use the **T-bar**, or the **TAKE** button.

You still have access to **STEP BACK** button.

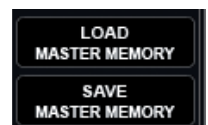

SEQUENCE:

The sequence feature consists on a timeline composed by 16 scenes. Each scene can be filled by a preset memory. Simply click on MM to choose the memory slot you want to put into the scene.

To select the memory, simply choose it into the list or drag and drop it into the scene box from the memories selection (on the right).



This toolbar acts like a command for your timeline.

Simply click on play to launch the timeline.

You can stop the timeline at any moment using the pause or stop button.

Use the loop button to load again your timeline when it's finished.

Take a look at the global time of your timeline thanks to the clock on the right of the toolbar.

Note: To control the **QuickVu**, Analog Way also provides Crestron and AMX modules. For more details, see appendices.

8. OPERATING THROUGH THE FRONT PANEL

8.1 Front panel

8.1.1 Menu navigation



To access the **QuickVu** menu, press the **EXIT/MENU** button in the control section. To highlight items in the menu which will appear on the VFD screen, turn the scroll knob left or right to the desired menu item. When you have reached the desired menu item, press the **ENTER** button in the control section to access that menu function. Pressing the **ENTER** button when a selection has been made sets the value to that selection in the **QuickVu** memory. When all settings have been made, press the **EXIT/MENU** button to exit sub-menus and return to the main menu.



Simply selecting a menu item will not set it to that value. Be sure to press the **ENTER** button when parametering the menu items or to push the scroll knob.

8.1.2 Home menu

Pressing the **MENU** button in the menu section of the **QuickVu**, will display and give you access to the following items on the menu VFD screen:

- **OUTPUT 1:** select to set the output types and resolutions of Output #1,
- **OUTPUT 2:** select to set the output types and resolutions of Output #2,
- **INPUT:** select to configure the 8 individual input types and resolutions,
- **PRESET:** select to store and use presets,
- **IMAGE*:** select to change source image settings of an input,
- **KEYING/TITLING*:** select to access keying and titling controls and parameters when video layer is selected,
- **SCREEN:** setup your background color and your Quick Frame,
- **LAYER*:** select to adjust layer size, position, transparency or transitions,
- **FRAMES:** select to store (record), use and manage frames into the **QuickVu**,
- **AUDIO:** select to access all audio input and output parameters,
- **CONTROL:** select to access device software information, LAN settings, reset factory settings, and other user oriented functions.

** These items are only displayed if a valid input is assigned to the current layer.*

8.1.3 Operating modes

The **QuickVu** offers 1 mode to work from: the Mixer mode.

8.1.4 Resetting default values





It is strongly recommended resetting all of the default values of your **QuickVu** unit before setting up your shows and events. This will help eliminate confusion caused by unneeded settings from a previous operator. To do so, press the **EXIT/MENU** button and select Control in the menu by rotating the corresponding knob. Then press the **ENTER** button to enter the **Reset/Erase** sub-menu. Select Default Values by rotating the scroll knob, and press the **ENTER** button to enter your choice to restart your **QuickVu** with its factory settings. This operation should take approximately 30 seconds.

8.1.5 QuickVu color codes

Analog Way engineers have developed a handy, user friendly way of identifying machine status on the front panel, via the use of color codes on the buttons of the machine. All new Analog Way machines use the same codes, for quick recognition of the status of any device of the range, at any given time.

For the **QuickVu**, button color codes are as follow:

- Sources on the Program output are indicated in **red** when active,
- Sources on the Preview output are indicated in **green** when active,
- Buttons in the layer section turn **red** or **green**, depending on whether the selected layer is active in respectively the Program or Preview window,
- menu buttons are indicated in green,
- Selecting a button with an available source or function will cause that button to blink **green** on the preview, or **red** once it is on the Program output,
- **TAKE** button reacts as follows:
 - If take function is available, the button will appear in **green**.
 - When the take function is active, it will light up red.

Solid red:		#1 = Source is on the Program output #2 = Freeze enable
Solid green:		#1 = Source is on Preview #2 = Function available for modification
Blinking red:		Layer/source selected or is currently active on the Program output
Blinking green:		Layer/source selected or is not currently active on the Program output

8.2 Settings in Mixer mode

8.2.1 Source Input selection

Plug your sources using the 4 multi-plug inputs, 2 HDMI Inputs or 2 3G/HD/SD-SDI inputs. Be sure that all connectors are firmly attached using all available locking screws.

8.2.2 Input selection settings

To set up your inputs automatically: **Input menu > Auto settings**

You can also do it manually on each input# using the **ENTER** and the Knob button and set up the inputs type one by one.

You can also check your actual input configuration using the config status: **Input menu > Config Status**

You can find several settings for each input (some settings are specific to some signal type):

- **INPUT STATUS:** display the input status,
- **AUTOSET:** launch an automatic setup on the inputs,
- **FREEZE:** freeze the input,
- **ACTIVE PLUG:** choose the active plug of the input,
- **TYPE:** to set up your input type (Computer, Video etc..),
- **AUTOSET:** launch an autosest on this plug,
- **ENABLE:** enable/disable the input#,
- **SYNCHRONIZED:** enable this option when you source is from the same refresh rate than the reference rate,
- **HDCP ENABLE:** enable/disable the HDCP automatic detection,
- **HSYNC LOAD:** to change the load of the sync signal,
- **3D COMBO FILTER:** choose manually the combo filter for interlaced source,
- **FORMAT:** for analog source, choose to force a analog format,
- **AUDIO INPUT:** select the input audio source according to the input video source,
- **EDID:** set up your EDID for the selected plug,
- **STATUS:** to summarize the input status.

Concerning the HDMI inputs, a specific feature allows enable/disable the HDCP receiver for the input chosen. It can be very useful especially using a Mac: **Input menu > HDMI # > HDCP detection**

NOTE: The input status is available at any time in the status input menu and can give you information about format rate and HDCP status.

8.2.3 Source Output selection

Once your inputs all have been configured, the output settings of the **QuickVu** must be set according to the machines plugged on your **QuickVu** Program and Preview outputs (video projector, Preview monitor...).

NOTE: If you want to use HDCP content from your sources, be sure to attach HDCP compliant screens or projectors. If HDCP sources are used with non-HDCP compliant screens, the output image could be disabled.

8.2.4 Output selection settings

To set up the output, go in the Output #1 (Program) or Output #2 (Preview) menu and choose first the adapted format/resolution, and then the appropriate rate for your screens by using the knob button and the **ENTER** button.

Output #1 > Output Format > Output rate

Please note that a pair format/rate is only applied when the rate is validated.

Use the native resolution of your screens/projectors in order to obtain the best image quality. In the Preview Output menu, you can also match the output configuration the Program Output to the Preview Output by checking the case Sync w/Out 1. It allows you to set up your outputs via the output 1 menu.

Output #2 > Synch w/Out 1

Some other settings are available too:

- **OUTPUT STATUS:** display the status of the selected output,
- **OUTPUT FORMAT:** choose the output format,
- **OUTPUT RATE:** choose the output rate,
- **GAMMA:** use this feature to set up the output gamma,
- **ANALOG TYPE:** set up the type of synchronization of your analog output,
- **DVI TYPE:** set up the type of color space of your digital output,

- **DVI as HDMI:** DVI output content as HDMI. Audio is included,
- **HDCP DETECT:** enable or not the HDCP detection on the output,
- **CENTERING PIC:** display the centering test pattern,
- **TEST PATTERN:** choose to display one of the available test pattern.

All changes have to be validated by pressing the **ENTER** button in order to be saved

NOTE: The output status can provide you all information about the output in real time. This feature is particularly needed when HDCP is used with long cable to be sure that the communication is well handled.

8.2.5 Preview features

The Preview output can display all adjustments before the TAKE.

All current layers for the Program are defined by a colorful frame on Preview. They are identified by a letter and a number with the same color.

- **Layer A:** Ax, with xx of 1 to 8,
- **Layer B:** Bx, with xx of 1 to 8, (*layer B is always keyed*)
- **Quick Frame.**

Because the number of resources available is limited, the Preview displays only one live or still layer at a time. The others are only identified by their colorful frame and their number.

8.2.6 Preview Id

The function disables all the display of ID information in Preview mode. The colored frames and numbers indicating your source selection on each layer are disabled. To set up your Preview Id:

menu > Control > Functions > Preview Id

8.2.7 Working with layers

- To assign a source to a layer, press the *Layer button*, press the Source# you want to assign.
Ex: Layer A > Source #4
The source number 4 will be displayed in the **Layer A**.
Press TAKE to view the result on the Program screen
- To delete a layer from the Preview screen:
Press Layers # > Press Black button
Press TAKE to view the result on the Program screen
- To clear all layers on your Preview screen:
Hold the Black button at least 3 seconds
Press TAKE to view the result on the Program screen
- To freeze a layer: **Select a Layer > Press Freeze button**

8.2.8 Working with layers functions

Once a source is assigned to a layer, you will have access to some layer settings in the *Layer menu* or directly by pressing the layer button.

The settings available depend on the layer selected:

- **Layer adjusts:** set up layer size and position,
- **Layer zoom:** set up layer zoom size and position,
- **Size Templates:** adjust a specific size (Fullscreen, 1/2, 1/3, ...),
- **Transparency:** adjust the layer transparency,
- **Opening and Closing effect:** adjust the Open/Close effect type and duration,

- **Smooth move:** enable/disable smooth move,
- **Status:** get the selected layer status.

All changes have to be validated by pressing the **ENTER** button in order to be saved
Press TAKE to view the result on the Program screen.

Settings available:

Settings	Background live / PIP#1	PIP#2
Position	YES	YES
Size	YES	YES
Zoom	YES	YES
Transparency	YES	YES
Opening effects	YES	YES
Closing effects	YES	YES
Smooth Move	YES	YES



2 layers

The Program output can be displayed simultaneously up to 3 layers stacked from bottom to top as follows:

- **Layer A:** one source selected from 8 inputs available,
- **Layer B:** one source selected from 8 inputs available (keying activated),
- **Quick Frame:** one of the 8 frames available.

8.2.9 Opening transitions and closing live layers

When transitioning live layers, depending on how many scalars are in use, the **QuickVu** TAKE function will act in one of 3 different ways when transitioning the next preset (Preview) to the current preset (Program):

• TAKE 1 - shot: Case #1

- There are enough scalars for making a transition
- All inputs are locked on to scalars
- There are no constraints for closing before the TAKE
- All opening and closing transitions can be performed simultaneously.

• TAKE 2 - shot: Case #2

- There are enough scalars for making a transition
- All inputs are locked on to scalars before the TAKE
- There are no constraints for closing during the TAKE
- All the necessary closing transitions are performed to free occupied scalars and then the **QuickVu** performs all openings.

• TAKE sequenced - shot: Case #3

- There are not enough scalars for making a transition
- All inputs are not locked on to scalars
- All the necessary closing transitions are performed to free occupied scalars. The **QuickVu** locks on to new sources and performs all openings.

8.2.10 Layer adjustment menu

- To have access to the layer adjustment menu, a source has to be affected to your layer:
Press Layer# button > Press source #
- To adjust layers:
Press Layer# button > Then go into Layer adjut menu
Press TAKE to view the result on the Program screen

8.2.11 Layers with transitions

Transitions

All the settings are available in the *Layer menu* after pressing the selected layer.
The transition effects have some shortcuts on the front panel too.

To use it: **Press the selected Layer # > Press Effect button, then choose the opening/closing effect**

The effect will be immediately attached to the selected layer (Preview).

- **CUT:** duration time can be set to delay the cut effect,

- FADE:

- Adjustable pre-timed fades or manual transition with T-Bar,
- Fade between any input, computer or video,
- Adjustable cross-fading duration,

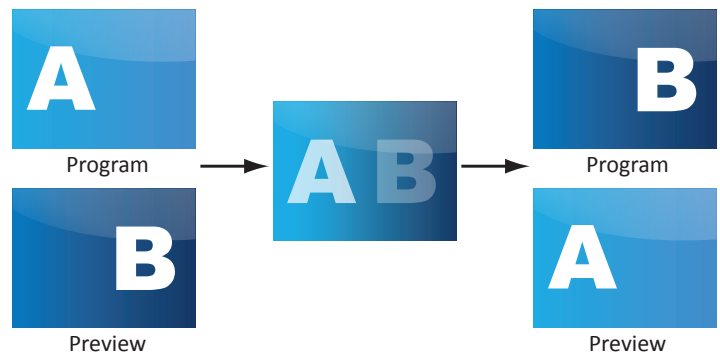

- WIPE:

- Numerous wipes can be selected horizontal and vertical, from the center or outside, in circle, Zoom in and out,
- Horizontal: from left, center -or- vertical: from up, down, center,



- SLIDE:

- Sliding of video or computer images during the transition,
- Horizontal: from/to left, right -or- vertical: from/to up, down.



The **QuickVu** offers 21 seamless transition effects.

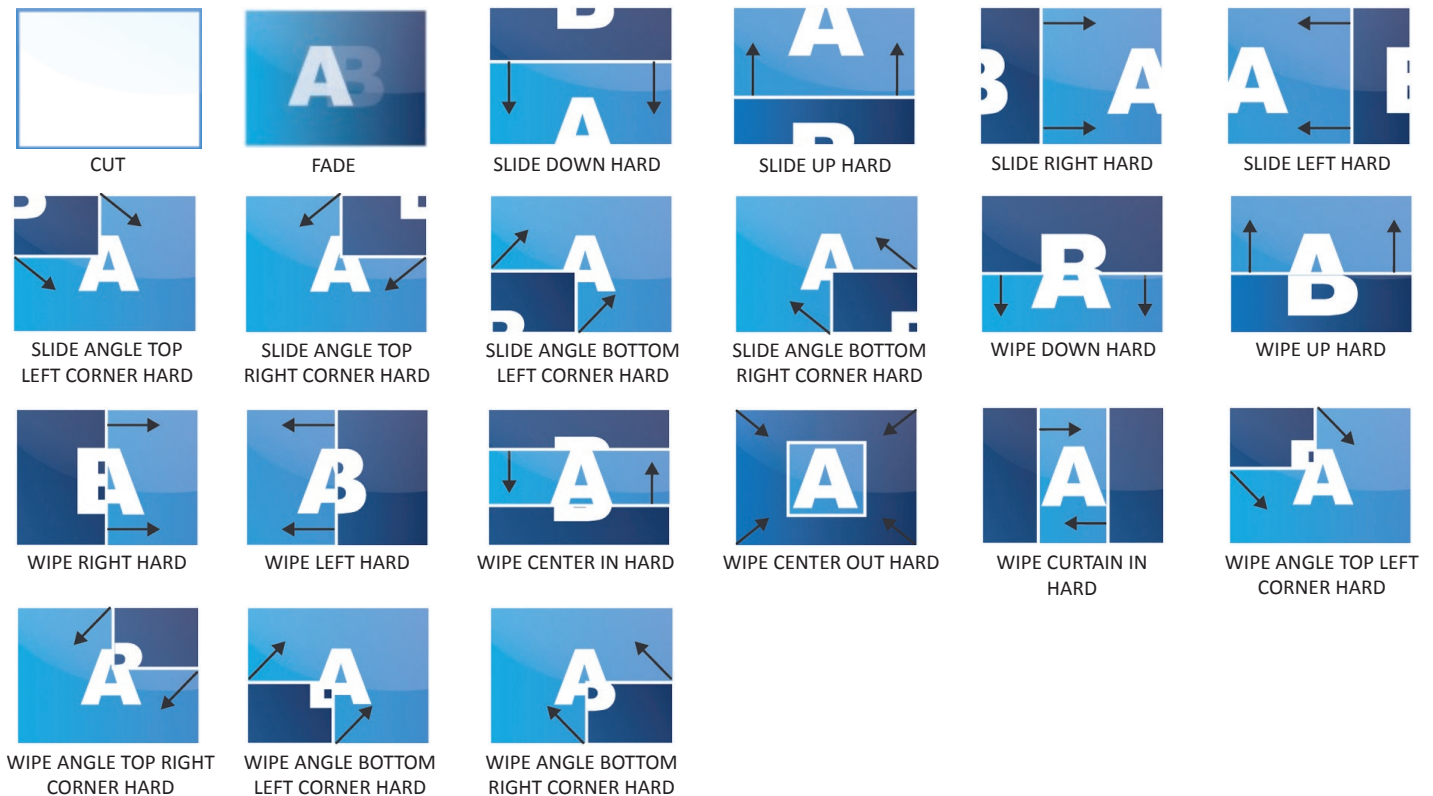

8.2.12 Capturing frames

It is possible to store up to 8 frames in the **QuickVu** non volatile memory. To capture a frame, display the exact content you want to save on one of your outputs, at the exact resolution, you can use the freeze button if you want. Then follow this step:

Frames menu > record Frame menu > Frame #

Choose the frame number slot and wait until the unit finishes to save. Your frame is now saved and you can use it through the frame button.

The capture of frames can be done only under the following conditions:

- The capture can be done from the Program output or the Preview output,
- The disappearance of frames on the Preview and Program output is normal during saving.

A frame captures the state of the specified output at the output resolution, and must be recalled using the same output resolution. Resizing or other image manipulation of the captured frame is not possible.

Attempting to use a frame at a different resolution will result in a partial frame display or a frame which does not fill the screen.

During the capture, the output is outlined by a white border and includes the pixels into the white rectangle.

8.2.13 Working with frames

Frames are mainly used as foregrounds in a typical show or event setup, and can be recorded from any of the **QuickVu** 8 sources and called back at the press of a single button. To use a Quick Frame, be sure first that it is well saved, affected to a Quick Frame, then:

Press Quick Frame button

NOTE: Frames may be used only one at a time and can be placed only in the Quick Frame layer.

8.2.14 Frame input setup menu

In the frame input setup menu, you have the possibility to save a frame, and the possibility to erase a stored frame:

Frames menu > save Frame > Frame #

Frames menu > Erase > Frame #

8.2.15 Creating presets

The **QuickVu** allows the creation of user defined presets very easily. Any setup you have configured on screen, can be stored into one of the 8 available user presets.

1. After having configured layers, transitions, ... on your screen, go to the *Preset* menu by pressing the **EXIT/MENU** button, and select *Preset* by rotating the scroll knob. Then, press the **ENTER** button to enter the *Preset* sub-menu. Choose *Preset Copy* by scrolling with the corresponding knob, and press the **ENTER** button to access the sub-menu.
2. In the sub-menu, choose *Save From Program* or *Save From Preview* to determine which screen you want to memorize the preset from, then set the preset memory (#1 to #8) you wish to use as your "User Preset" (by default, the **QuickVu** will choose the next available preset in the **QuickVu** memory).

By pressing the **ENTER** button, the **QuickVu** will ask you to confirm. Select *Yes*, your screen is memorized as a preset.

8.2.16 Working with presets

The 8 user presets of the **QuickVu** can be recalled at any stage during your show or event.

1. Press the **PRESET** button, then press one of the eight first preset buttons to choose which memory (#1 to #8) you wish to use. The preset will be displayed on your Preview screen.
2. Once you have selected your preset, simply press the **TAKE** button to view the result on your main screen.

8.2.17 Working with audio

Into the audio menu, you will find some audio adjustments:

- **Audio mode:**

- **NO AUDIO:** the audio of your device is switched off
- **PRESET MODE:** the standard mode of use of the device

You have two possibilities:

- **Top layer:** the sound on the output will follow the audio input of the top layer.
- **Breakaway:** when breakaway is activated, the audio on the output is memorized into the preset. A change of preset, changes the audio on the output. A change of content into a video layer has no effect on the audio.
- **ROUTING MODE:** in this configuration, simply choose an audio input to assign it to the output. The audio configuration remains the same during the show.

- **Source settings:** into this menu you will have access to all source settings:

- **ANALOG SETTINGS:**

- **Mute:** select to mute the input
- **Stereo:** select to choose between mono or stereo input
- **Analog gain:** set up the analog gain of your analog input (0 for 4dBu)
- **Level/balance:** select to adjust the input audio level and right and left balance.

- **DIGITAL AUDIO:**

- **SPDIF/AES3:** choose the digital audio output mode

- **Main audio/prelist audio:** define the main or prelist audio settings:

- **PRESET MODE:**

- **Top layer:** the sound on the output will follow the audio input of the top layer.
- **Breakaway:** when breakaway is activated, the audio on the output is memorized into the preset. A change of preset, changes the audio on the output. A change of content into a video layer has no effect on the audio.
- **Master mute:** select to mute your master audio
- **Stereo:** select to choose between mono or stereo output
- **Analog level:** set up the analog gain of your analog output (4dBu by default)
- **Master volume:** set your master volume of the output
- **Balance:** set the right/left balance of your output.

8.2.18 Special features

- **DYNAMIC FIT** (automatically activates the transparent background)

- Automatic adjustment of the layer (Ratio) to fit the source image borders during a transition.

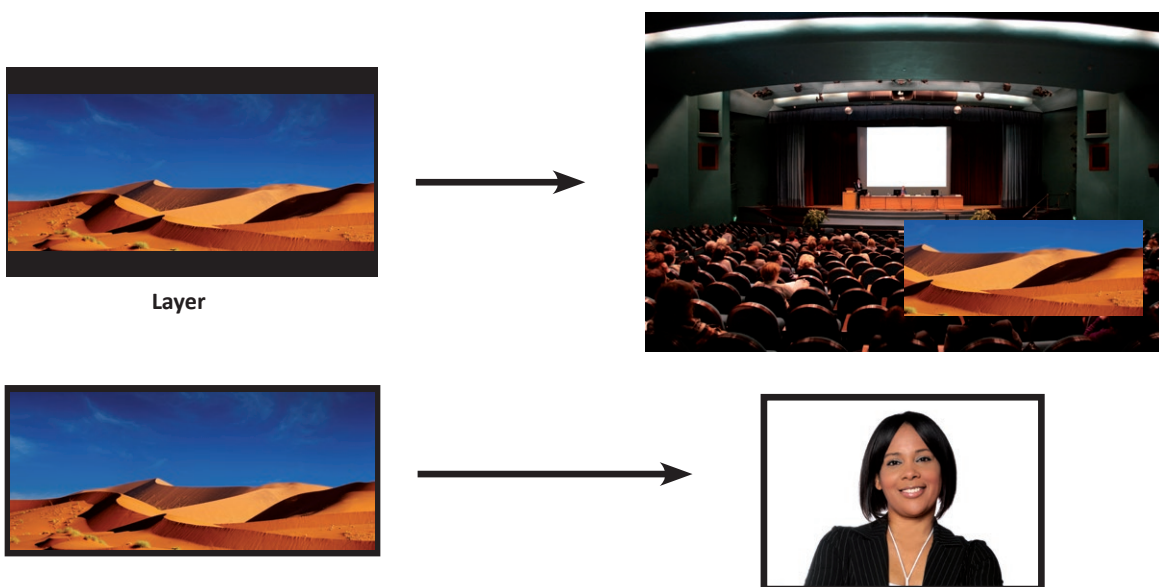

- Dynamic & Automatic adjustment of the layer to fit the source image borders (Black Stripe).

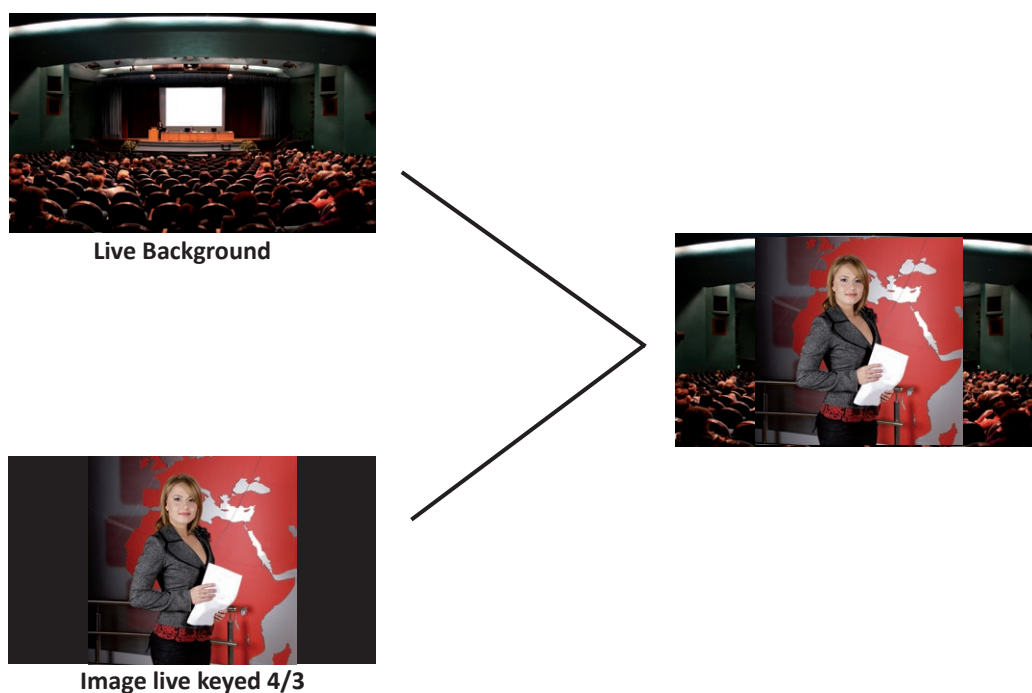

- SMOOTH MOVE EFFECT

- Smooth Move layer control the acceleration of the layer. The time can be different between the opening and closing layer,

- WORKING WITH DSK (Chroma / Luma key)

- **QuickVu** allows to use a live source with green or blue (or any color) background and to key it over another live input,
- Background is removed and replaced by another source,
- Title can be keyed (DSK) on Analog or Digital Sources.

To use keying, first select a source in the desired layer:

Layer button > source number button

Then in the main menu, select the Keying/Titling menu.

You now have several choices to key your sources. The Luma Key and the Chroma Key based on the Luma pixel values and the Chroma pixel values and for both an additional Titling menu which can be useful to choose the transparency value of your keying.

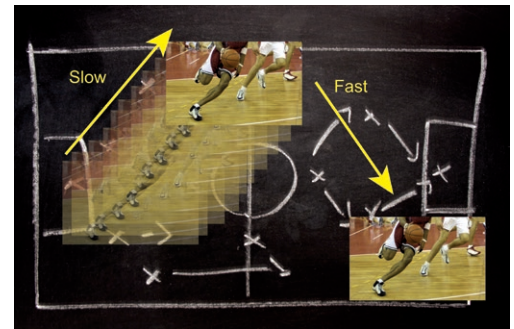

Keying/Titling menu > Type menu > Select your keying type

Once your keying mode is selected, the **QuickVu** provides you some keying advance setting:

For Luma Key:

- Luma Keying is used to key from a particular luminous intensity. It produces a hard edged key based on intensity, which is most suitable for titling effects. You can choose to key things that are extremely dark or extremely bright and keep everything in between, or invert to key only things that are of a medium intensity.
- The black and white levels define where to begin the keying. In the range 0 to 255, 0 represents no luminance, or black and 255 represents full luminance, or white.
 - **Level Black:** As the Black Level is changed from 0 to 255, things that are black are first keyed out, followed by dark grey, then light grey, and so forth, until the entire picture is keyed out at 255.
 - **Level White:** As the White Level is changed from 255 to 0, things that are white are first keyed out, followed by light grey, then dark grey, and so forth, until the entire picture is keyed out at 0.

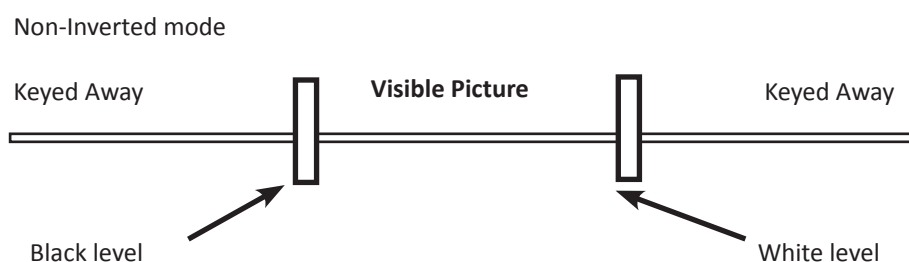

For Chroma Key:

Chroma Keying is used to key from a particular color. It produces a key which is most suitable for moving images and “weatherman” style applications.

- Color grabber:

Select Chroma Key menu > Select Color grabber menu

Using a crosshair, you can select a particular hue based on what is on screen. Once you have adjusted the crosshairs to a desired position, press set/enter to capture the color value at that instant. You can then adjust the other parameters such as Tolerance to further refine your key.

- Manual Setting:

Select Chroma Key menu > Manual Settings menu

- **R,G,B:** these controls allow you to manually select a hue, defined by its Red, Green, and Blue values as you can find in Windows (Paint software).
- **Tolerance:** the Tolerance parameter allows you to expand your key color selection to include colors which are similar to the selected value. A tolerance of 1 will select only the desired hue, whereas a tolerance of 255 will select nearly all hues.
- **Black Level:** this option permits adjustment of the luminance levels of the keyed hue. The Black Level is the luminance lower bound. Colors in the selected hue range with a luminance brighter than the Black Level but darker than the White Level will be considered part of the key.
- **White Level:** this option permits adjustment of the luminance levels of the keyed hue. The White Level is the luminance upper bound. Colors in the selected hue range with a luminance brighter than the Black Level but darker than the White Level will be considered part of the key.
- **Titling alpha:** if you have selected one of the two Titling mode, the titling menu appears. This option places a transparent black backdrop behind the entire layer to which the key is applied. This effect is useful for using bright titles on bright backgrounds, such as clouds.
- **Invert keying:** by default, this mode is disabled. When this mode is activated, the key selection will remain on screen, and all other portions of the image will be keyed away. For example, you would see the green screen behind the actor, while the actor would be keyed away.

8.3 Menu tree

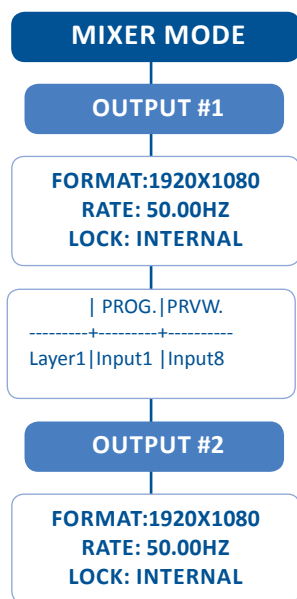

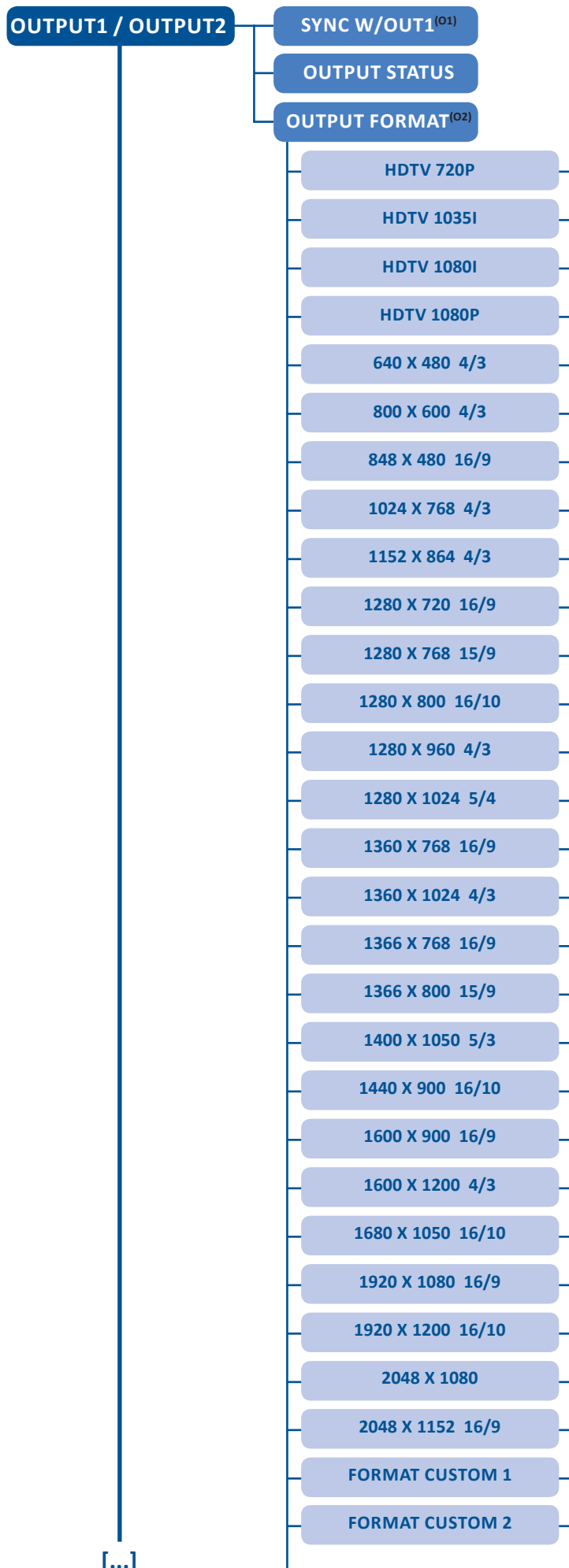

(O1) Only for OUTPUT 2
(O2) For OUTPUT 2, only displayed when OUTPUT2 is not synchronized with OUTPUT1
(O3) Depending on the output format
(O4) Only for interlaced output format
(O5) Only Computer and HDTV

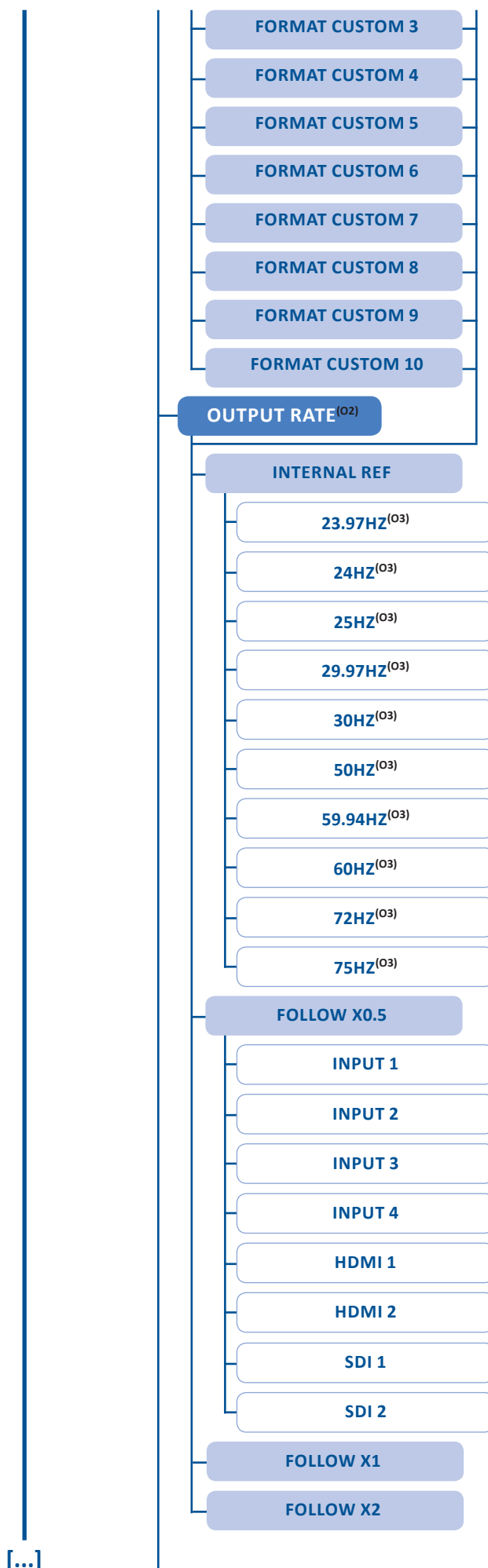

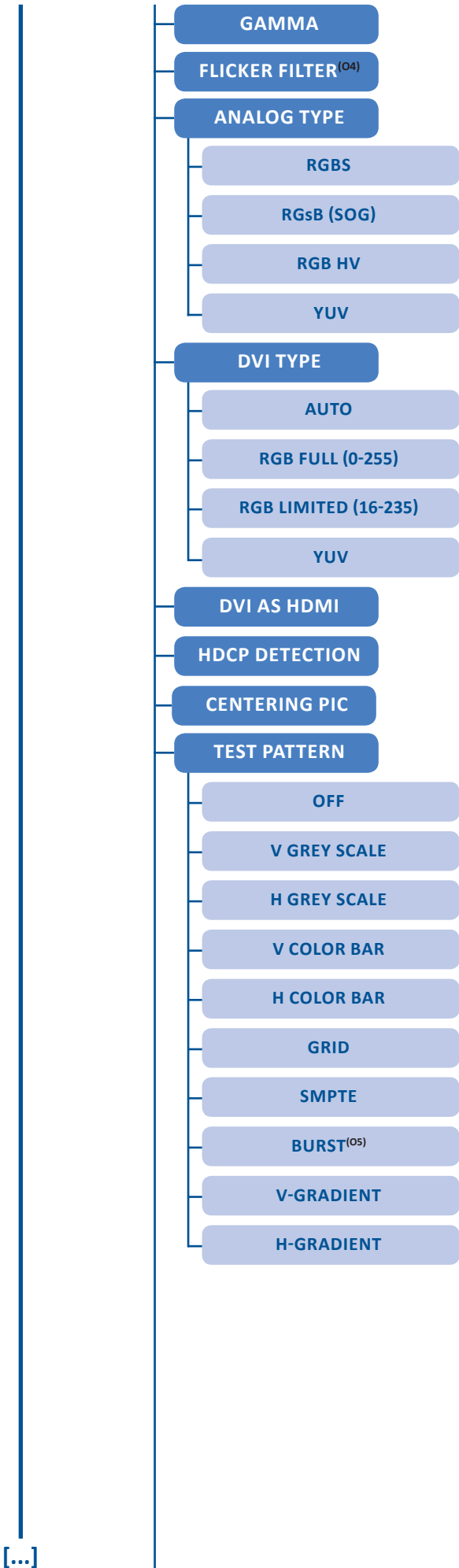

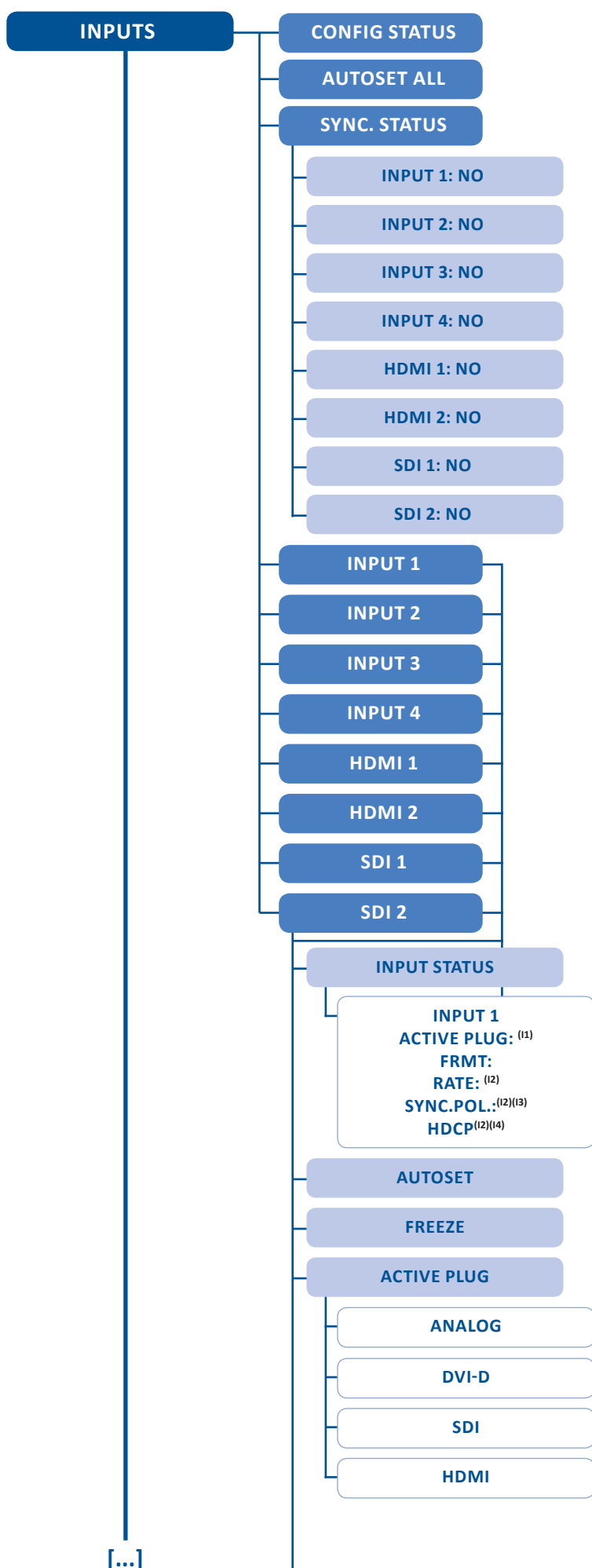

- (11) Displayed when input is a multiplug input.
 (12) Displayed when a valid input signal is detected
 (13) Displayed when it is an analog plug and when the signal is computer HV type
 (14) Displayed for HDMI and DVI-D plugs
 (15) Displayed when the plug is analog, DVI-D or HDMI
 (16) Displayed when the plug is analog
 (17) Displayed when the plug is analog and the signal type is VIDEO RGBS
 (18) Displayed when the plug is not SDI

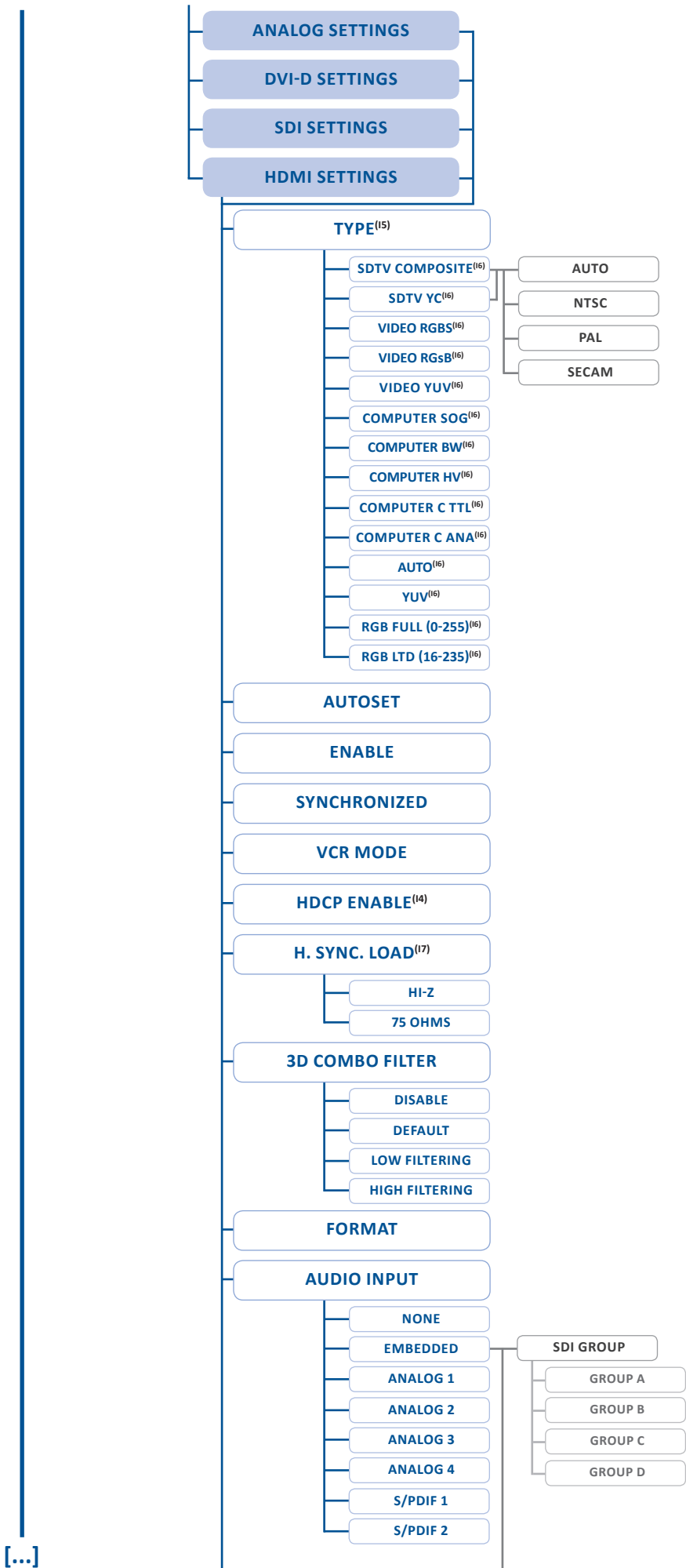

[...]

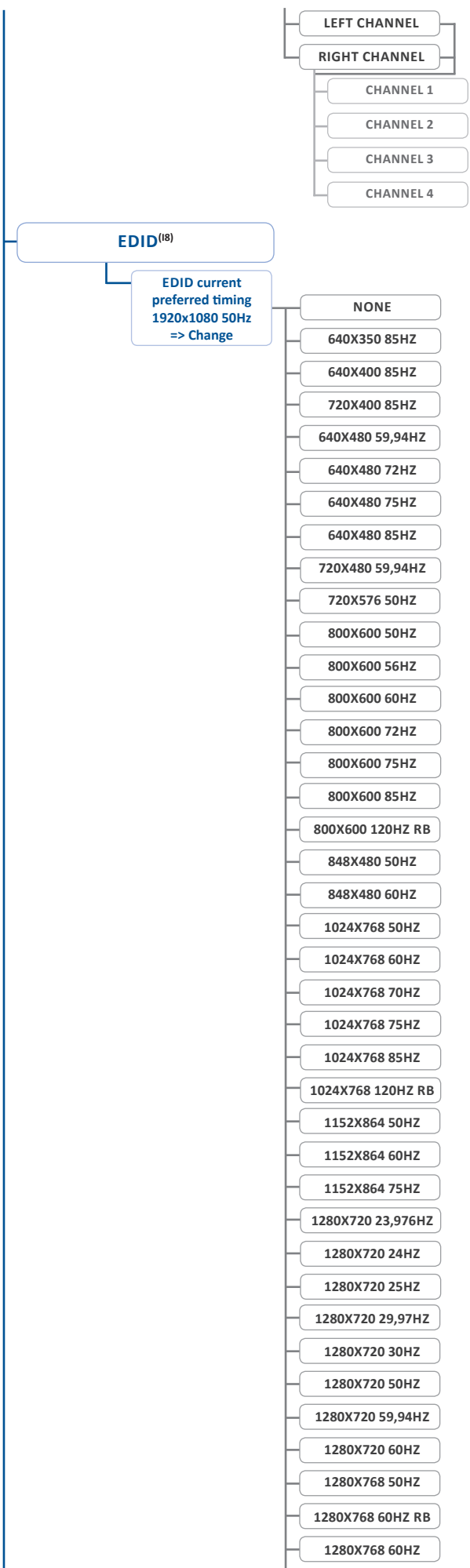

[...]

- 1280X768 75HZ
- 1280X768 85HZ
- 1280X768 120HZ RB
- 1280X800 50HZ
- 1280X800 60HZ RB
- 1280X800 60HZ
- 1280X800 75HZ
- 1280X800 85HZ
- 1280X800 120HZ RB
- 1280X960 50HZ
- 1280X960 60HZ
- 1280X960 85HZ
- 1280X960 120HZ RB
- 1280X1024 50HZ
- 1280X1024 60HZ
- 1280X1024 75HZ
- 1280X1024 85HZ
- 1280X1024 120HZ RB
- 1360X768 50HZ
- 1360X768 60HZ
- 1360X768 120HZ RB
- 1360X1024 50HZ
- 1360X1024 60HZ
- 1366X768 50HZ
- 1366X768 60HZ RB
- 1366X768 60HZ
- 1400X1050 50HZ
- 1400X1050 60HZ RB
- 1400X1050 60HZ
- 1400X1050 75HZ
- 1400X1050 85HZ
- 1400X1050 120HZ RB
- 1440X900 50HZ
- 1440X900 60HZ RB
- 1440X900 60HZ
- 1440X900 75HZ
- 1440X900 85HZ
- 1440X900 120HZ RB
- 1600X900 50HZ
- 1600X900 60HZ RB
- 1600X1200 60HZ
- 1600X1200 60HZ
- 1600X1200 65HZ
- 1600X1200 70HZ
- 1600X1200 75HZ
- 1600X1200 85HZ
- 1600X1200 120HZ RB
- 1680X1050 50HZ

- 1680X1050 60HZ RB
- 1680X1050 60HZ
- 1680X1050 75HZ
- 1680X1050 85HZ
- 1680X1050 120HZ RB
- 1920X1080 23,976HZ
- 1920X1080 24HZ
- 1920X1080 25HZ
- 1920X1080 29,97HZ
- 1920X1080 30HZ
- 1920X1080 50HZ
- 1920X1080 59,94HZ
- 1920X1080 60HZ
- 1920X1200 50HZ
- 1920X1200 60HZ RB
- 2048X1080 23,976HZ
- 2048X1080 24HZ
- 2048X1080 25HZ
- 2048X1080 29,97HZ
- 2048X1080 30HZ
- 2048X1080 50HZ
- 2048X1080 59,94HZ
- 2048X1080 60HZ
- 2048X1152 50HZ
- 2048X1152 60HZ RB

STATUS

(P1) Only displayed with a valid preset
 (P2) Only displayed if there is no valid preset

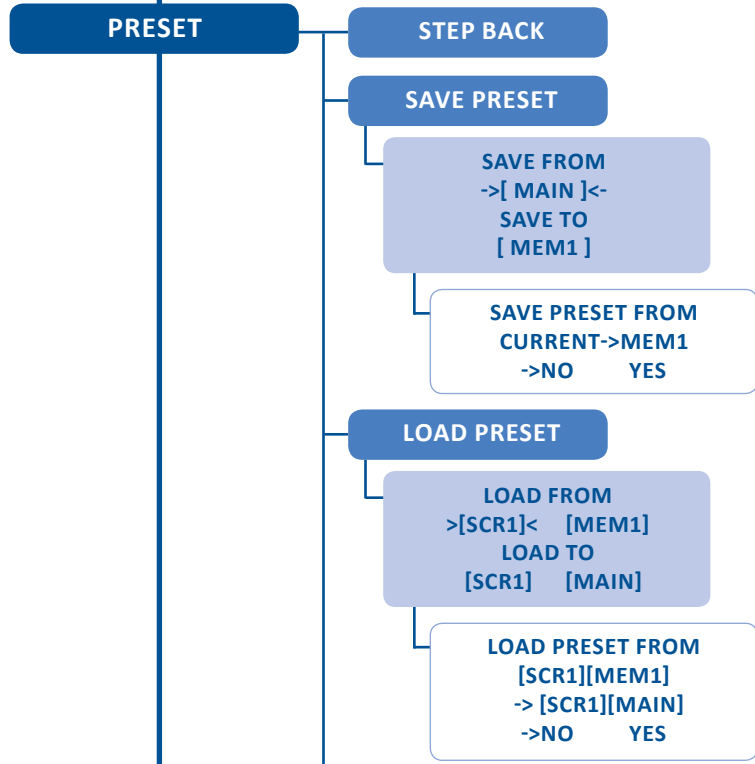

[...]

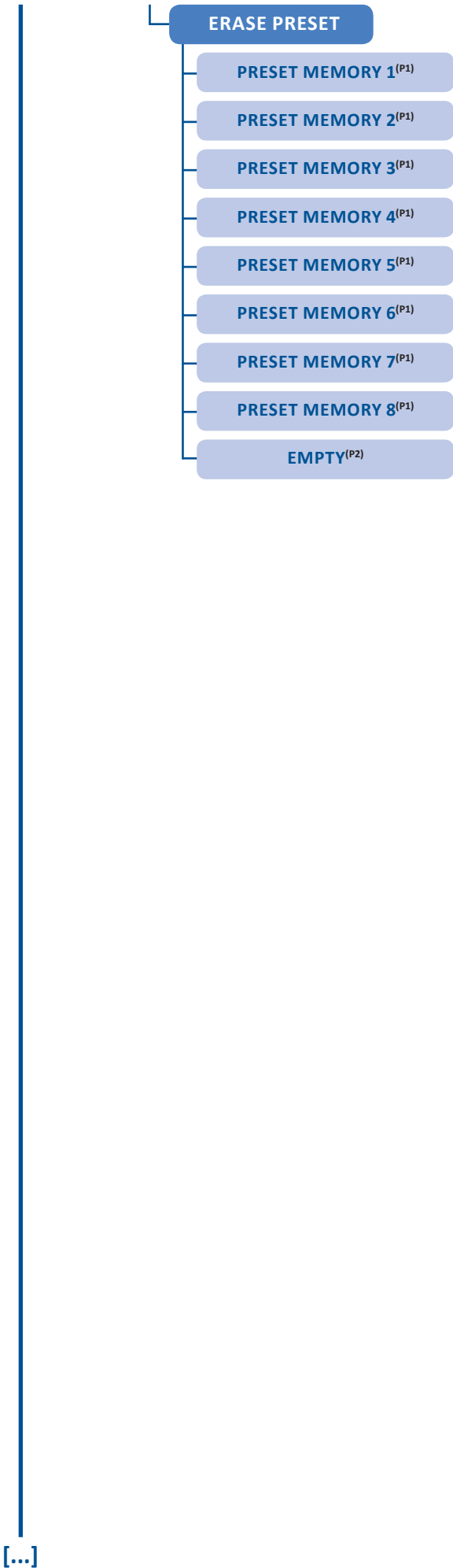

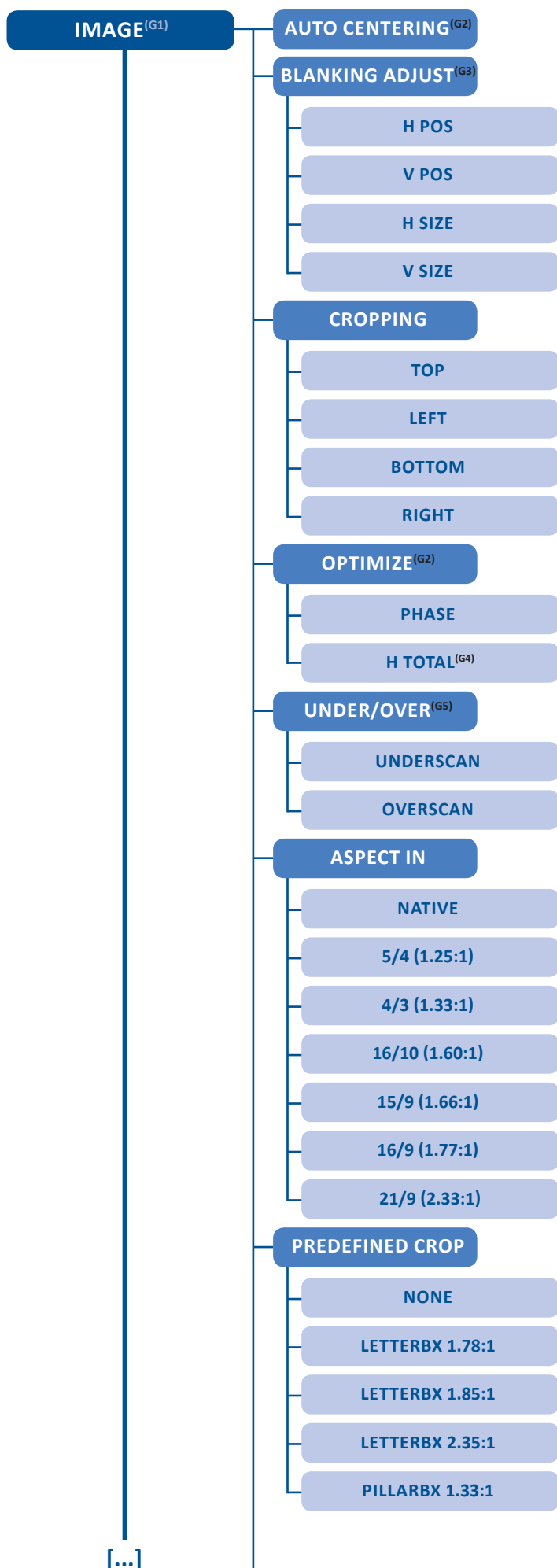

(G1) Displayed when a valid input is affected to a layer

(G2) Displayed for computer analog signal, EDTV and HDTV analog video

(G3) Displayed for analog signal

(G4) Displayed for computer analog signal

(G5) Displayed for video signal

(G6) Displayed for interlaced signal

(G7) Displayed for 50 hz interlaced signal and non-activated low latency

(G8) Displayed for 60 hz interlaced signal and non-activated low latency

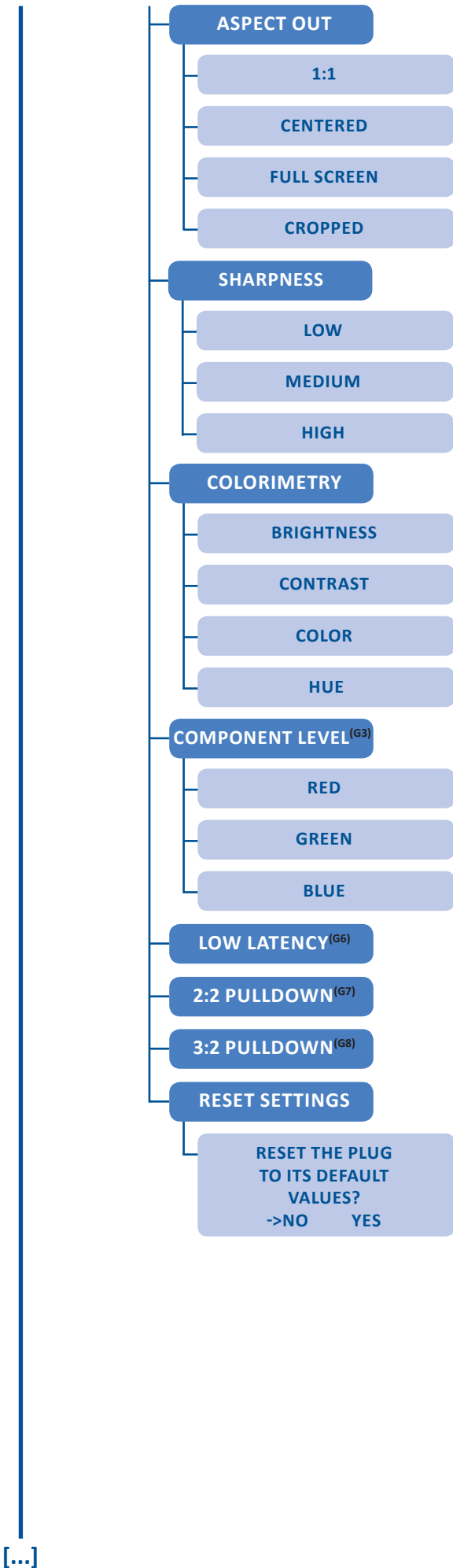

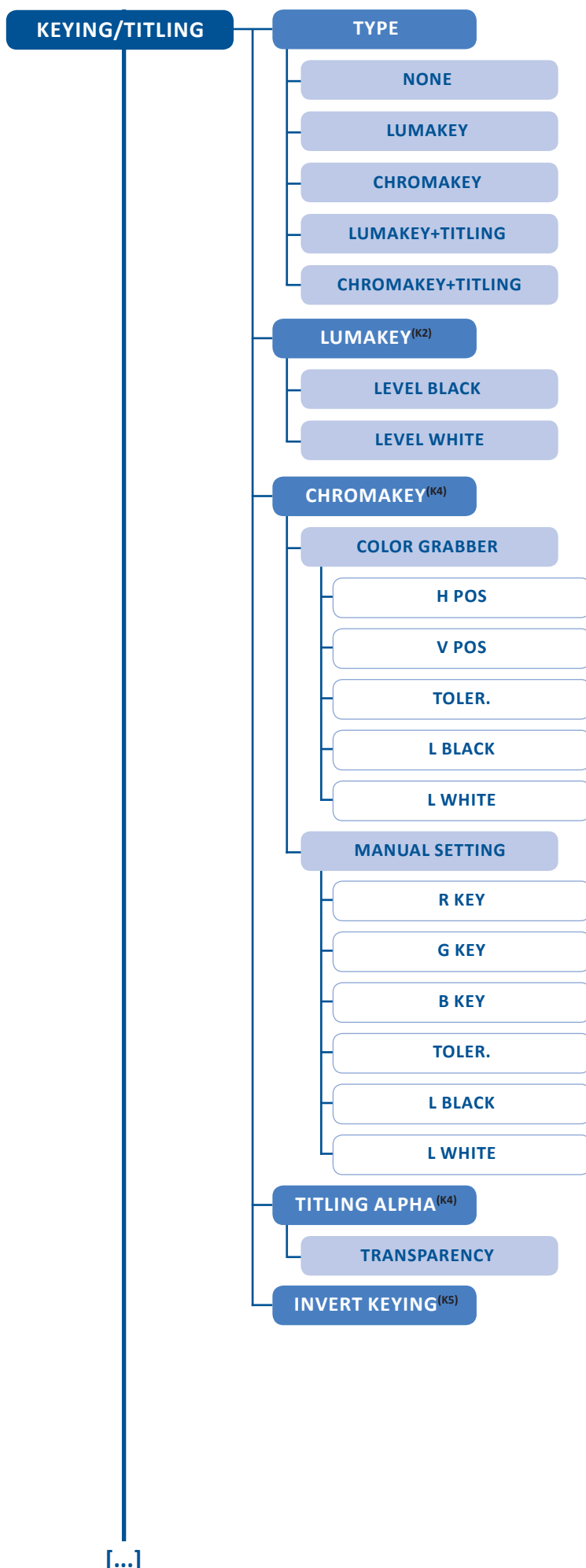

- (K1) Displayed when a valid input is affected to a layer
 (K2) Only displayed for Type = Luma key or Lumakey +Titling
 (K3) Only displayed for Type = chroma key or chromakey +Titling
 (K4) Only displayed for Type = Lumakey +Titling or Chromakey +Titling
 (K5) Only displayed for Type different that None

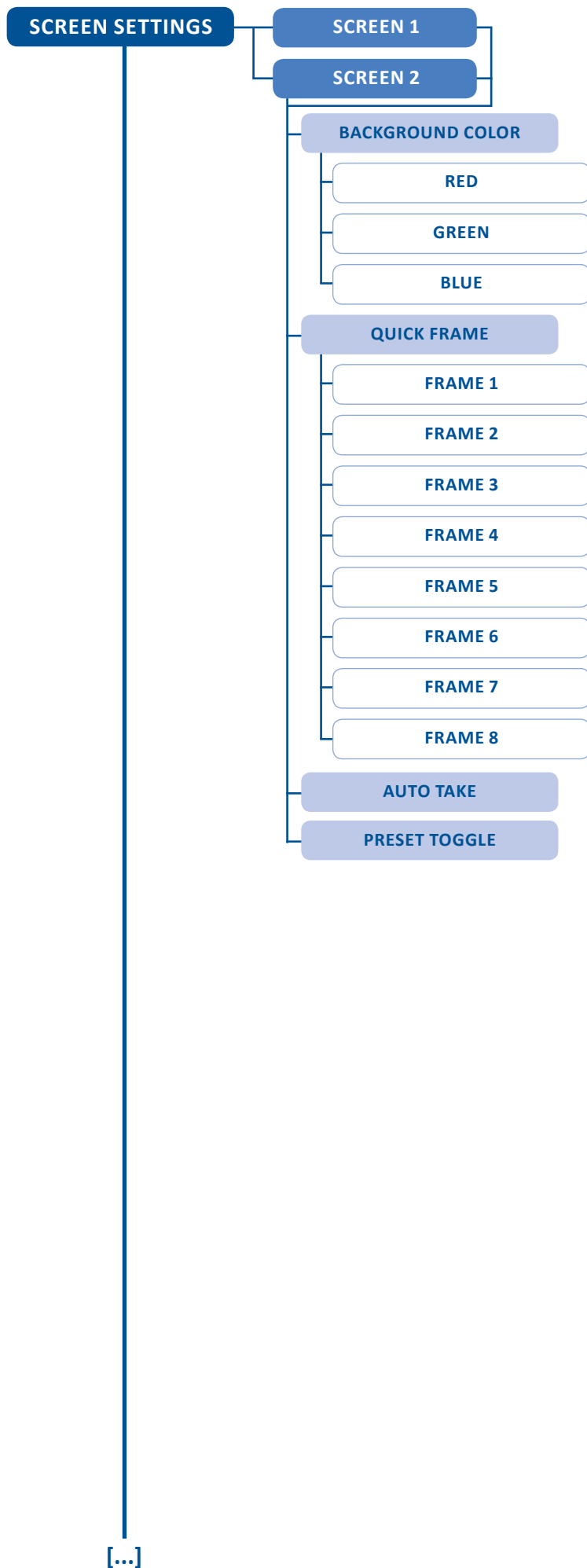

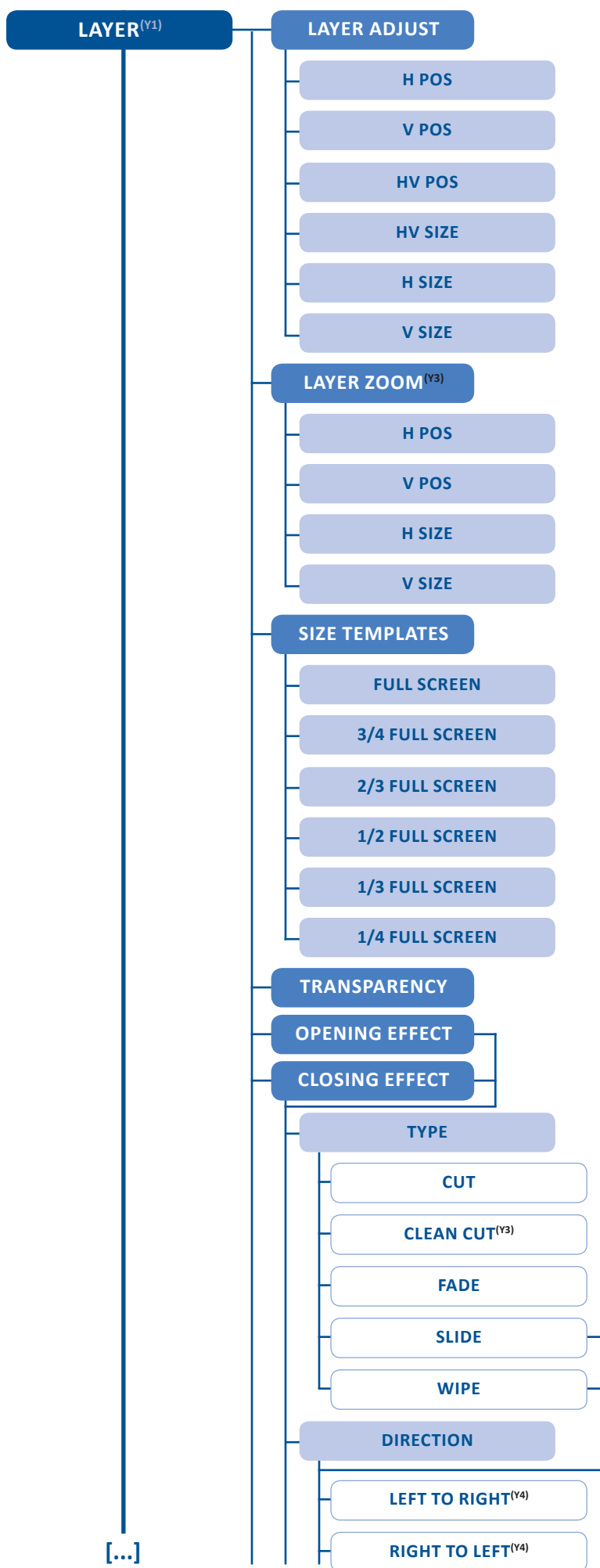

(Y1) Displayed when a valid input is affected to a layer

(Y3) Not available for frame

(Y4) Only slide and wipe

(Y5) Only wipe

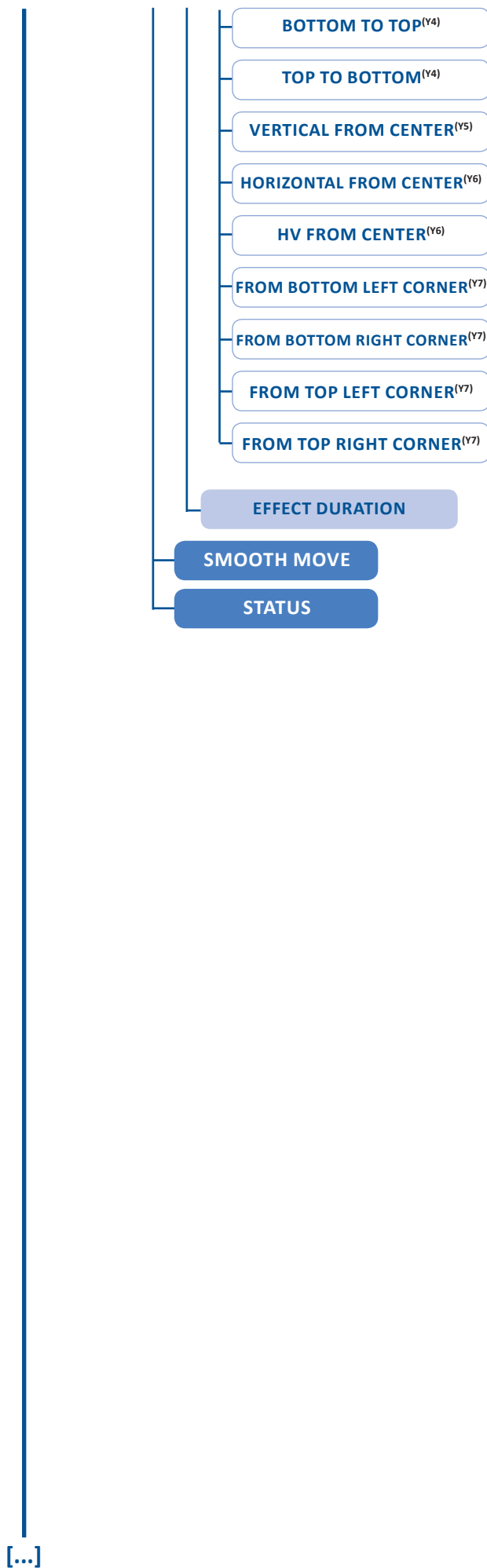

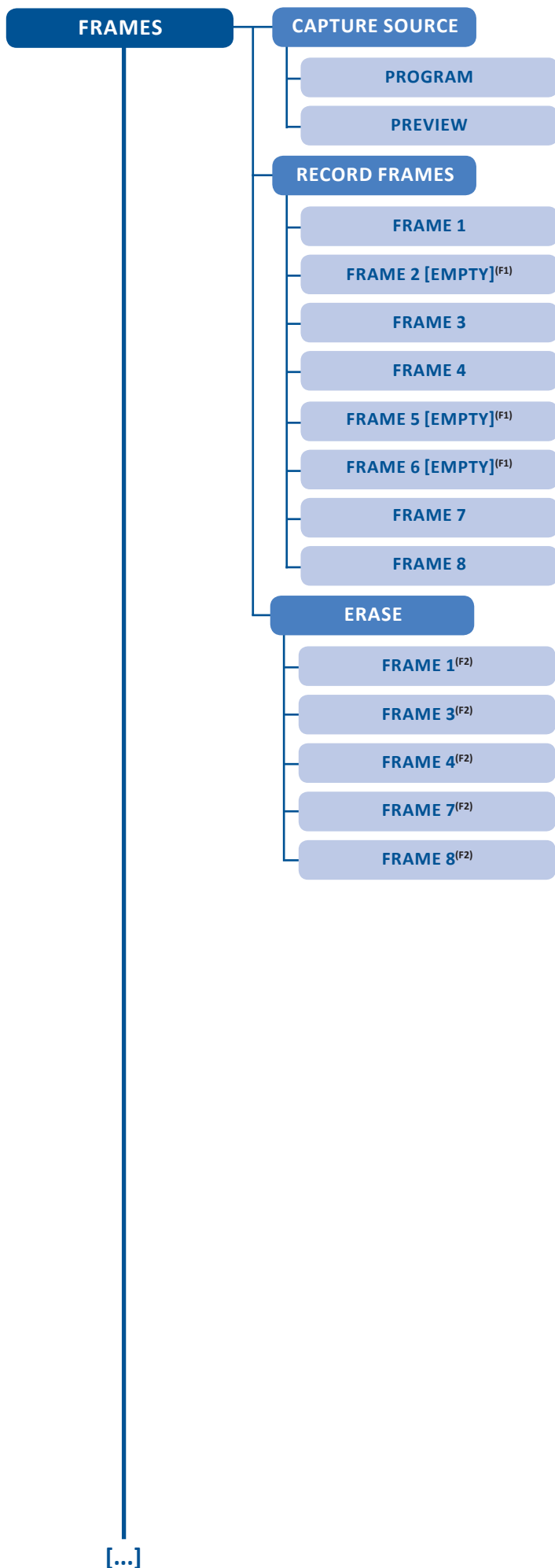

(F1) Display “empty” is the slot is free
(F2) Only displays valid frame list

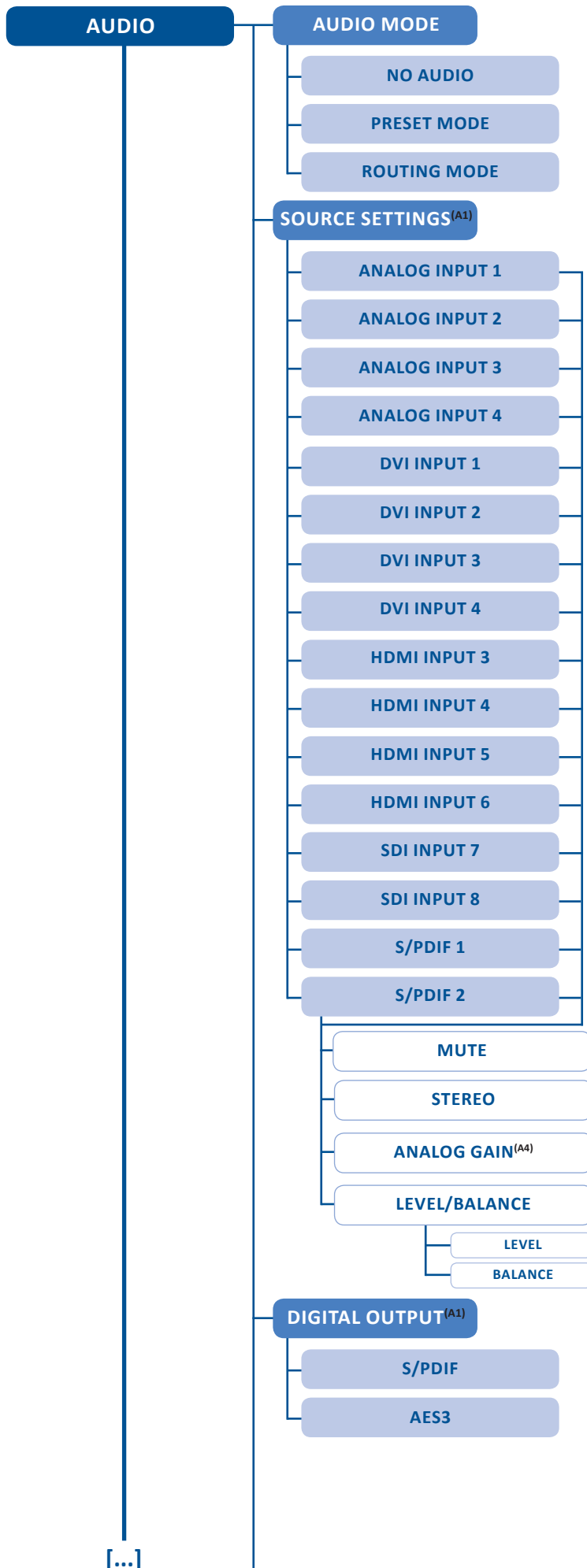

(A1) Displayed if the audio mode is different of “no audio”
 (A2) Displayed if the audio mode is “routing mode”
 (A3) Displayed if the audio mode is “Preset mode”
 (A4) Displayed if the audio input is analog
 (A5) Displayed if the delay mode is manual

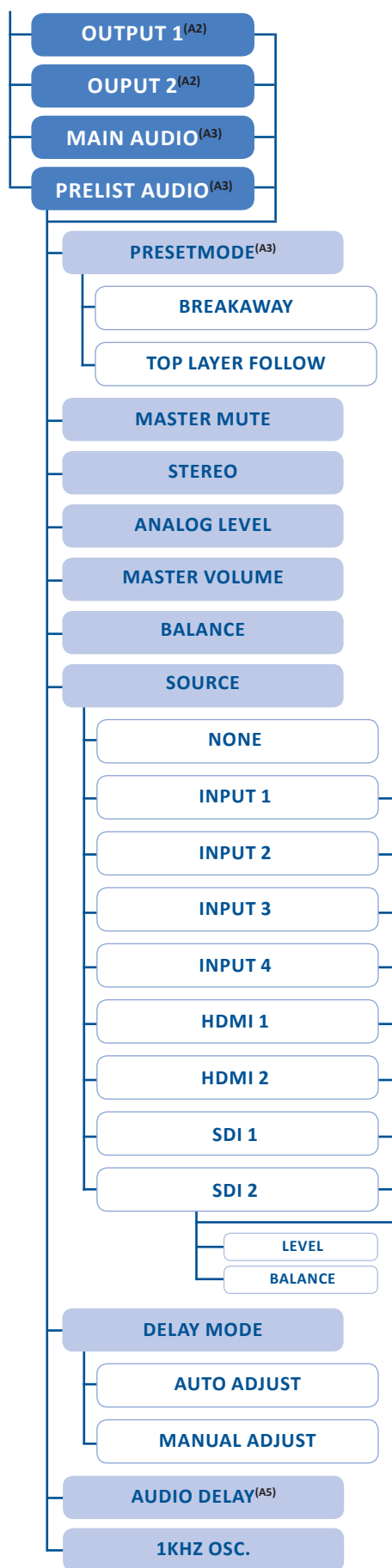

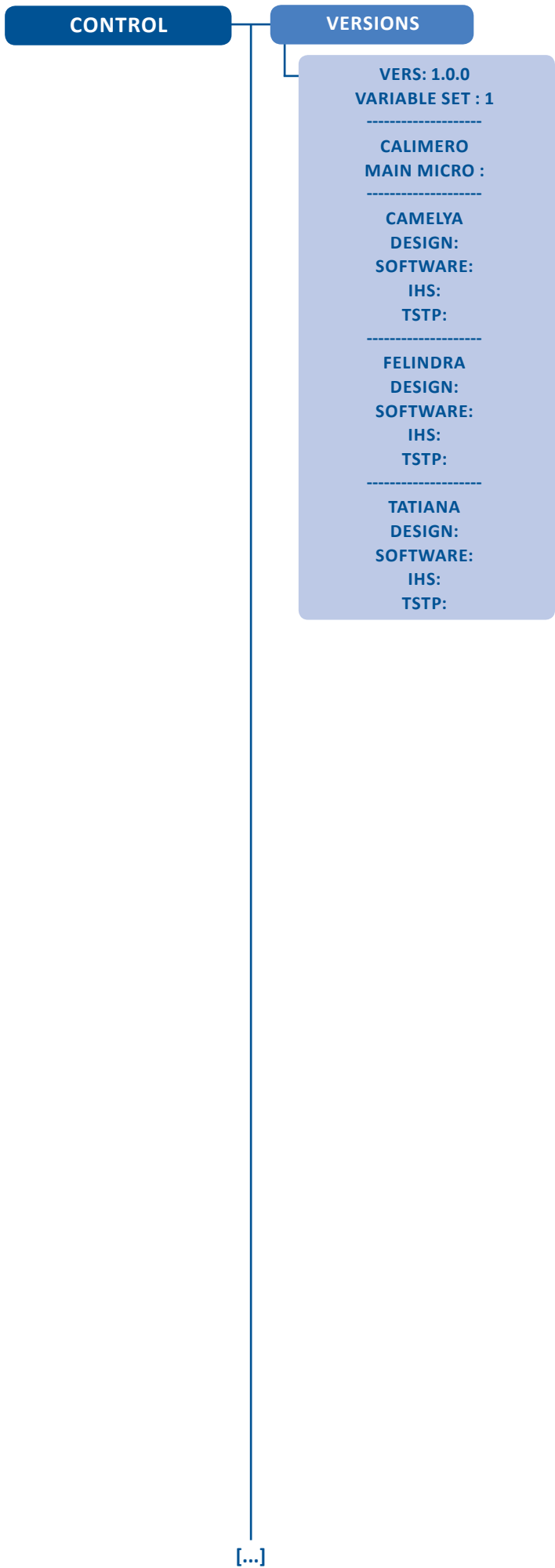

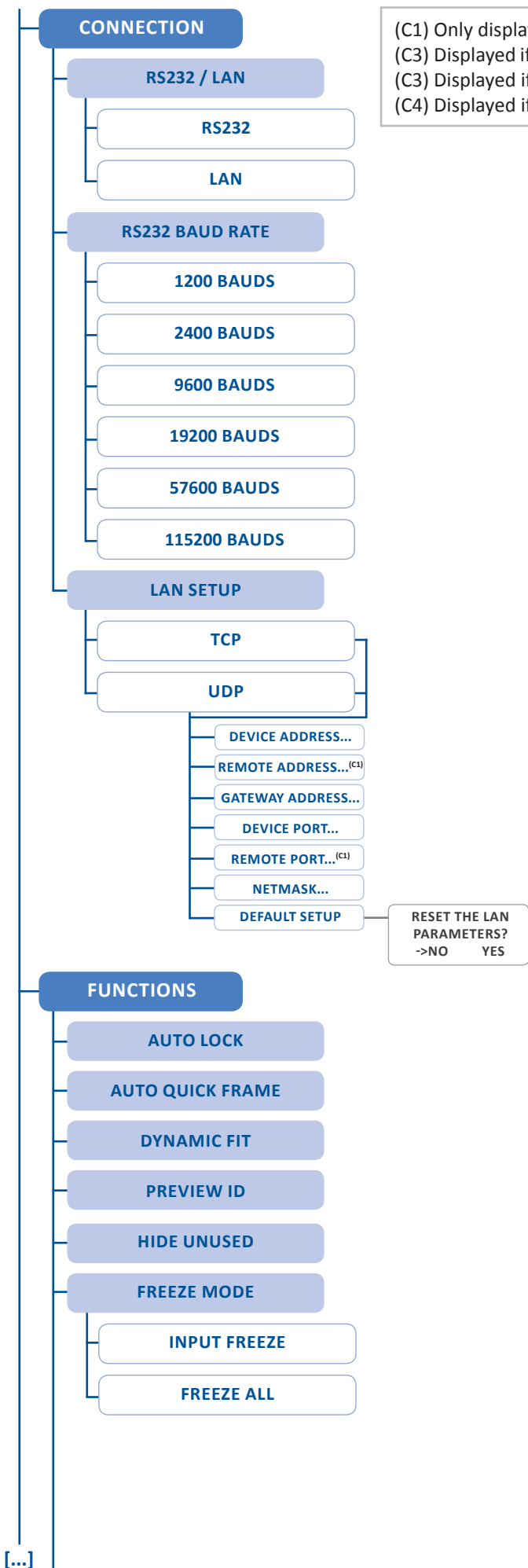

[...]

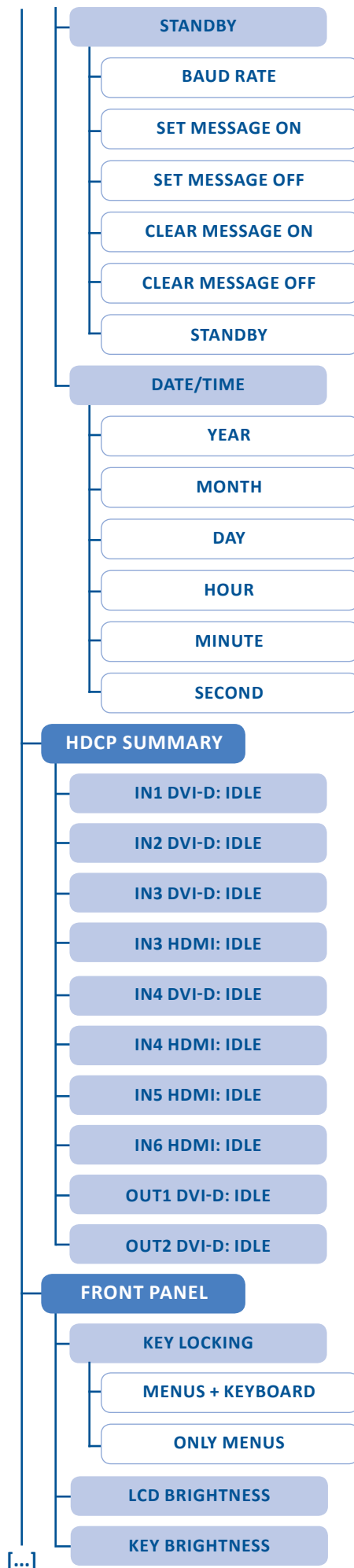

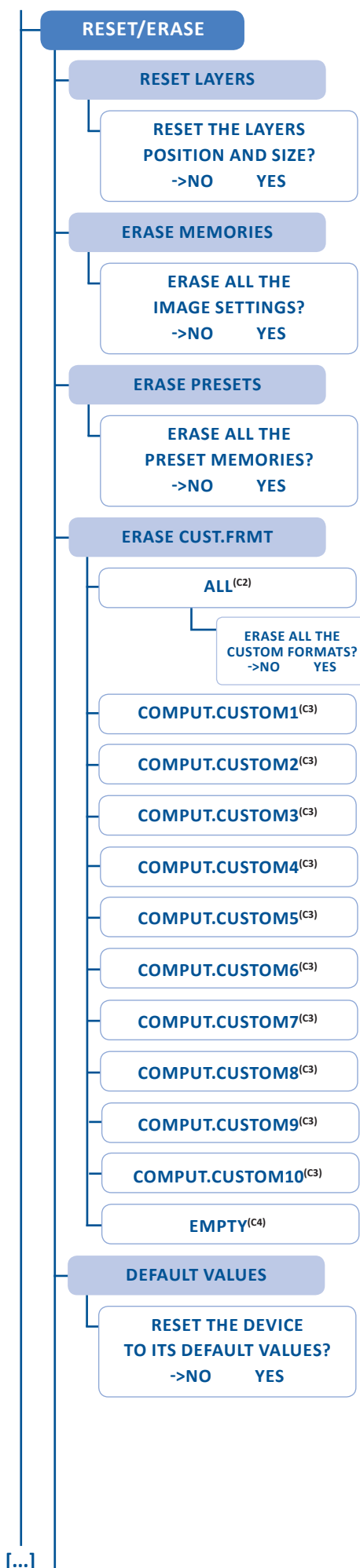

TECH. SUPPORT

THE AMERICAS
TECHSUPPORT@ANALOGWAYUSA.COM
TEL: +1 212 269 1902

EUROPE, MIDDLE EAST AND AFRICA
TECHSUPPORT@ANALOGWAY.COM
TEL: +33 (0)1 81 89 08 76

ASIA, PACIFIC
TECHSUPPORT@ANALOGWAYASIA.COM
TEL: +65 6292 5800

9. MAINTENANCE AND SUPPORT

9.1 Dashboard (RCS²)

On the RCS², you have access to a chart with general information on the unit.

Please click on the Dashboard button: **Dashboard**

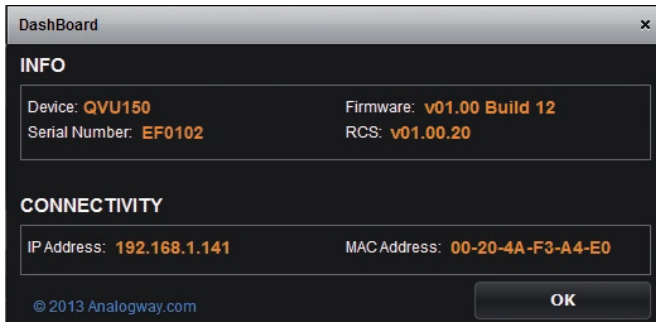

On this chart, you will find under the **INFO** tab, the Device name, the Serial number of your product, the actual firmware and the software version of the RCS².

Under **CONNECTIVITY**, you will find the current IP address of your unit and its MAC address.

10. APPLICATIONS NOTE AND TIPS

10.1 HDCP

HDCP is a content protection mechanism which uses encryption to prevent high value content from being delivered to non-authorized devices. For example, Blu-ray players use HDCP on their HDMI outputs to ensure that the HDMI output cannot be routed to a digital recording device.

The **QuickVu** is fully HDCP compliant, meaning that you will be able to use the **QuickVu** to accept HDCP protected sources and route them to any HDCP protected outputs. As Analog Way is a licenced HDCP adopter, this also means that the **QuickVu** is prevented from displaying any HDCP protected images on any non-HDCP compliant outputs (as is the case for all licenced HDCP compliant devices).

HDCP can only be used on certain connection formats, including DVI, HDMI, and Displayport. Keep in mind that simply because a connection is using a DVI, HDMI, or Displayport connection, it does not guarantee that the devices connected are maintaining an active HDCP connection. For example, you may find video recording or capture devices equipped with an HDMI input, however HDCP licencing forbids these devices from capturing HDCP protected content.

HDCP is not supported on connection formats such as composite, component, Svideo, SD-SDI, HD-SDI, 3G-SDI, or VGA. This means that any source which becomes protected by HDCP cannot be converted to these formats. For example, while you may find a Blu-ray player which can directly output a composite video signal, HDCP licencing forbids converting the HDCP protected HDMI signal back to composite or any other non-protected format.

To help troubleshoot HDCP in your installation, each input and output page is equipped with HDCP status information to indicate in realtime when HDCP encryption is being used.

Certain devices such as Macintosh computers can be misleading to use in conjunction with an HDCP compliant presentation switcher such as the **QuickVu**. This is because devices like the Mac computers can be used to output both HDCP protected content (such as a movie downloaded from iTunes) as well as non-HDCP protected content (such as a Keynote presentation or the desktop). When a computer first connects to an HDCP compliant device such as the **QuickVu**, it learns the capabilities of the device through the EDID connection. Upon seeing the HDCP compatibility of the attached **QuickVu**, devices like the Mac computers will immediately attempt to use HDCP encryption at all times, despite the content currently displayed on the computer screen. Since this source would now be considered an HDCP protected source, the **QuickVu** would be required to prevent it from being displayed on VGA or SDI outputs and only allow it to be displayed on outputs protected by HDCP. To work around this problem, the **QuickVu** allows the HDCP features of a particular input to be disabled, which in turn informs the Mac computer to avoid using HDCP, and allows content such as Keynote and the desktop to be displayed, as this input will no longer use HDCP protection. Please note that disabling the HDCP features of the input do not circumvent HDCP protections, and thus do not allow you to view any content which requires this protection.

For more information about HDCP, please refer to our whitepapers on HDCP, or visit the HDCP foundation website.

11. WARRANTY

11.1 Warranty conditions

Analog Way warrants the product against any defects in materials and workmanship for a period of three (3) years from the date of purchase when used in accordance with the user's manual and standard industry practices.

- In the unlikely event of any malfunction from such defects during the warranty period, Analog Way will, at its discretion, repair or replace the defective units.
- The warranty does not apply if the product is determined to have been:
 - Improperly installed or abused,
 - Handled with improper care,
 - Used or stocked in abnormal conditions,
 - Modified, opened,
 - Damaged by fire, war, or Natural disasters (Acts of God)
- Analog Way's direct employees are solely authorized to make this determination.
- Analog Way reserves the right to refuse for repair and service a product for which the warranty is void.
- In no way shall Analog Way be responsible for direct or indirect loss of profit or consequential damages resulting from any defect in this product.

NOTE: Analog way offers a warranty extension of 2 years, it includes parts, labor and return shipping. If you are interested, please contact your territory sales representative.

11.2 Repair and return instructions

These Return Material Authorization (RMA) regulations determine the procedure to be followed when returning defective product. The aim is to ensure fast and simple handling of the returned product and bring the best satisfaction

In the unlikely event that a product is required to return for repair, please call the regional Maintenance center/Customer Service, and ask to receive a Return Material Authorization number (RMA). Three regional maintenance centers are available depending on your location. (*See chapter: 12. Contact information*)

- Before sending any device to Analog Way, please contact us to obtain a Return Material Authorization (RMA) number. Please have the model and serial number available and the reason for calling.
- RMAs are valid for 30 days, after which a new RMA must be requested.
- Package the unit securely in the original shipping materials or suitable equivalent. Analog Way is not responsible for damage which occurs due to improper packaging. The customer assumes responsibility until the unit arrives at our facility.
- Out-of-warranty products will be charged an evaluation fee if no problems are found or if you choose not to proceed with the repair.
- Discontinued products are not admitted for return and repair.
- Be sure to include the RMA number clearly on the shipping label or on the exterior of the package.
- No unit will be accepted without a valid RMA clearly visible.

11.3 Return conditions

In the unlikely event that you want to return the product, please call the regional Maintenance center/Customer Service

- If you are unhappy with the performance of any product purchased from us, you can return it within 30 days of purchase.
- Returned equipment must be in original condition with all accessories and packaging materials.
- Returns may be subject to a refurbishment and/or restocking fee.

12. CONTACT INFORMATION



- The Americas
- Europe, Middle East & Africa
- Asia Pacific

Analog Way SAS - Headquarters

Tel.: +33 (0)1 81 89 08 60
 Fax: +33 (0)1 57 19 04 54
 2/4 rue Georges Besse
 92160 Antony
 FRANCE

Sales/General information:
saleseuro@analogway.com

Technical support:
techsupport@analogway.com
 Tel.: +33 (0)1 81 89 08 76

Analog Way Germany
 Tel.: +49 7161 5075668
salesgermany@analogway.com

Analog Way Inc.

Tel.: +1 212 269 1902
 Fax: +1 212 269 1943
 299 Broadway, Suite 1620
 New York, NY 10007
 USA

Sales/General information:
salesusa@analogway.com

Technical support:
techsupport@analogwayusa.com

Analog Way Italy
 Tel.: +39 02 39493943
salesitaly@analogway.com

Analog Way Pte Ltd

Tel.: +65 6292 5800
 Fax: +65 6292 5205
 152 Beach Road
 #15-03 Gateway East
 SINGAPORE 189721

Sales/General information:
sales@analogwayasia.com

Technical support:
techsupport@analogwayasia.com

Analog Way UK
 Tel.: +44 (0)2076 979133
salesuk@analogway.com

13. APPENDICES

13.1 Crestron 2 & 3 series Midra™ Driver



Using this driver, software developers and integrators can easily provide powerful solutions for remotely controlling any Midra™ series Switchers through Crestron 2-series or 3-series Control Systems®.

The package includes:

- The precompiled driver modules that can be used for recalling presets, selecting source inputs, changing PIP content, configuring audio inputs and outputs...,
- One sample SIMPL program that demonstrates the use of all the features available within this driver (3 projects provided, targeting Crestron QM-RMC, MC3 and CP2E Control Systems®),
- Two VTPro sample projects, one for XPanel and one for the Crestron Mobile Pro® application (for iPad® and Android™ devices), both running with the sample program mentioned above,
- Help files in French and English.

The samples provided are ready-to-use programs and can be freely adapted or used as a base to build your own real-world Midra™ controller application.

13.2 AMX NetLinx® Integrated Controllers Midra™ Driver



Using this driver, software developers and integrators can easily provide powerful solutions for remotely controlling any Midra™ series Switchers through AMX NetLinx® integrated controllers.

The package includes:

- The precompiled driver modules that can be used for recalling presets, selecting source inputs, changing PIP content, configuring audio inputs and outputs...,
- One sample NetLinx® Studio program that demonstrates the use of all the features available within the driver,
- Two TPDesign4 sample projects, one for AMX Modero® S Touch Panels and one for Apple® iPad, both running with the sample program mentioned above,
- Help files in French and English.

The samples provided are ready-to-use programs and can be freely adapted or used as a base to build your own real-world Midra™ controller application.



Follow us



ANALOG WAY[®]
Pioneer in Analog, Leader in Digital